



THE BASEMENT WATCHDOG™

BIG DOG

A/C-D/C Battery Backup Sump Pump System

Instruction Manual & Safety Warnings





A/C-D/C Battery Backup Sump Pump System

Pump was activated alarm

OFF ● ON

<p>Warning</p> <ul style="list-style-type: none"> ● Battery fluid low Add distilled water to battery ● Battery problem Check cables, tighten and clean. Replace battery, if necessary. Press white button 1 second to reset alarm. ● Power failure Check home circuit breaker or fuse. Make sure power plug is in wall outlet. Check AC fuse on back of unit. ● Pump failure Check Basement Watchdog pump for blockage and remove debris. Replace pump if necessary. ● Pump was activated Check main pump system for failure. Push white button 1 second to reset alarm. ● Battery fuse has blown Replace 25 amp DC fuse on back of unit. ● Battery hooked up backwards . . . Switch battery cables to opposite terminals. 	<p>What to do</p> <p>Push 1 second to test or reset alarm</p> <p>Push 4 seconds to silence alarm for 24 hours</p>	<p>Battery charge level</p> <ul style="list-style-type: none"> ● 100% ● 75% ● 50% ● 25% ● Pumping (Pump can run without water) ● Charging battery ● System operating
--	--	--

The Basement Watchdog...Watching Out for You!

Table of Contents

Important Safety Warnings and Instructions		Understanding the Warning Lights and Alarms	
Electrical precautions	1	Silencing the alarm	10
Battery preparation	1	Battery fluid is low	10
Battery precautions	1	Battery problem	11
		Cleaning battery terminals	11
Introduction		Replacing the battery	12
Items included in system	2	Power failure	12
Additional items needed	2	Pump failure	12
System specifications	2	Pump was activated	13
Replacement parts list	2	Replacing the pump	13
		Battery fuse has blown	13
Pump & Pipe		Battery hooked-up backwards	13
Installation Instructions		Battery charge level	13
Installation options	3	Pumping	14
Direct discharge to outside	4	Charging battery	14
Connection to existing discharge	5	System operating	14
Direct discharge for narrow sumps	6		
Connection to existing discharge for narrow sumps	7	Testing the System	
		Testing the float switch	14
Battery Instructions	8		
Control Unit Connections		Parts & Service Information	
Positioning the float switch	9	Technical support	14
Connecting the pump	9		
Installing the battery fluid sensor	9	Warranty	14
Connecting the battery	9		
Connecting to AC power	10	Troubleshooting Guide	15
Selecting the main or backup mode	10		

IMPORTANT: Even if you have the Basement Watchdog backup sump pump system installed by someone else, you must read and follow the safety information contained in this manual. Failure to do so could result in property damage, serious injury, or death.

Important Safety Warnings & Instructions

SAVE THESE INSTRUCTIONS. This manual contains important SAFETY WARNINGS and OPERATING INSTRUCTIONS for the Basement Watchdog battery backup sump pump system. You will need to refer to it before attempting any installation or maintenance. **ALWAYS** keep these instructions with the unit so that they will be easily accessible.

Failure to read and follow these warnings and instructions could result in property damage, serious injury, or death. It is important to read this manual, even if you did not install the Basement Watchdog backup sump pump, since this manual contains safety information regarding the use and maintenance of this product. **DO NOT DISCARD THIS MANUAL.**

ELECTRICAL PRECAUTIONS

⚠ DANGER

Risk of electrical and fire hazard. May result in death, serious injury, shock or burns.

To help reduce these risks, observe the following precautions:

- **DO NOT** walk on wet areas of the basement until all power has been turned off. If the main power supply is in a wet basement, call an electrician.
- **NEVER** handle the control unit with wet hands or while standing on a wet surface.
- **ALWAYS** unplug the control unit and disconnect the cables from the battery before attempting any maintenance or cleaning.
- **ALWAYS** unplug the main pump when installing or servicing the backup pump to avoid electric shock.
- **DO NOT** expose the control unit to rain or snow.
- Pull the plug rather than the cord when disconnecting the control unit.
- An extension cord should not be used unless

absolutely necessary. If an extension cord must be used, be sure the plug has the same configuration as the plug on the control unit.

- Use of an attachment not recommended or sold by the manufacturer may result in a risk of fire or injury from an electrical shock.
- **DO NOT** operate the computer control unit if it has received a sharp blow, been dropped, or otherwise damaged in any way. Contact Glentronics technical support at 800-991-0466, option #3.
- **DO NOT** disassemble the control unit. When service is required, contact Glentronics technical support at 800-991-0466, option #3. Return the control unit to the manufacturer for any repairs at the following address:

Glentronics, Inc.
640 Heathrow Drive
Lincolnshire, IL 60069

BATTERY PREPARATION

⚠ WARNING / POISON

Sulfuric acid can cause blindness or severe burns. Avoid contact with skin, eyes or clothing. In the event of accident, flush with water and call a physician immediately. **KEEP OUT OF REACH OF CHILDREN.**

To help reduce these risks, observe the following precautions:

- Someone should be within range of your voice or close enough to come to your aid when you work near a lead-acid battery.
- Have plenty of fresh water and soap nearby in case battery acid contacts skin, clothing or eyes.
- Wear eye and clothing protection and avoid touching your eyes while working with battery acid or working near the battery.
- If battery acid contacts skin or clothing, wash immediately with soap and water. If acid enters eye, immediately flood eye with running cold water for at least 10 minutes and get medical attention.

- Battery posts and terminals contain lead and lead compounds, chemicals known to the State of California to cause cancer and reproductive harm. Wash hands after handling.

BATTERY PRECAUTIONS

⚠ DANGER

Explosive gases could cause serious injury or death. Cigarettes, flames or sparks could cause battery to explode in enclosed spaces. Charge in well-ventilated area. Always shield eyes and face from battery. Keep vent caps tight and level.

To help reduce these risks, observe the following precautions:

- **NEVER** smoke or allow a spark or flame in the vicinity of the battery.
- Use the Basement Watchdog control unit for charging a LEAD-ACID battery only. Do not use the control unit for charging dry-cell batteries that are most commonly used with home appliances.
- Be sure the area around the battery is well ventilated.
- When cleaning or adding water to the battery, first fan the top of the battery with a piece of cardboard or another non-metallic material to blow away any hydrogen or oxygen gas that may have been emitted from the battery.
- **DO NOT** drop a metal tool onto the battery. It might spark or short-circuit the battery and cause an explosion.
- Remove personal metal items such as rings, bracelets, watches, etc. when working with a lead-acid battery. A short circuit through one of these items can melt it causing a severe burn.
- **ALWAYS** remove the power cord from the electrical outlet before connecting or disconnecting the battery cables. *Never allow the rings to touch each other.*
- Check the polarity of the battery posts. The POSITIVE (+) battery post usually has a larger diameter than the NEGATIVE (-) post.

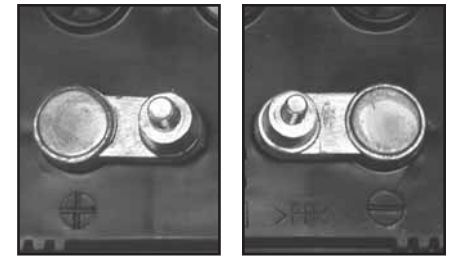

POSITIVE POST HAS LARGER DIAMETER

NEGATIVE POST HAS SMALLER DIAMETER

- When connecting the battery cables, first connect the small ring on the end of the WHITE wire to the NEGATIVE (-) post of the battery, and then connect the large ring on end of the BLACK wire to the POSITIVE (+) post of the battery.

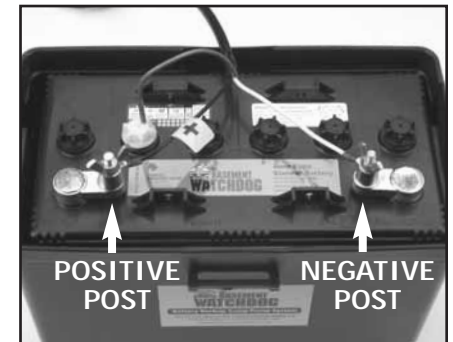

⚠ DANGER

Do not use system to pump flammable or explosive fluids such as gasoline, fuel oil, kerosene, etc.

Introduction

The Basement Watchdog A/C-D/C backup sump pump system is strong enough to be used as your main and only pump, but we recommend using it as an emergency battery backup system to support your regular AC sump pump. It has a state-of-the-art monitoring system, and it will automatically begin pumping if your main AC pump fails. Should any malfunction or emergency occur that involves the sump pump, the battery, or the AC power, your Basement Watchdog system will sound an alarm. A light on the display panel of the control unit will indicate the cause of the alarm and the corrective action.

If the main AC pump breaks or is unable to keep up with all the incoming water, the Basement Watchdog pump is capable of running without discharging the battery as long as the AC power is on.

The Basement Watchdog Sump Pump System includes:

- A control unit with a float switch and a battery fluid level sensor
- A pump with 1½" PVC pipe adapter
- A plastic wire tie for mounting the float switch
- A battery box
- A battery cap with a hole to accommodate the fluid sensor

You will also need to supply:

- A Basement Watchdog 7.5 Hour Standby Battery, or another deep cycle battery
- 1½" rigid PVC pipe and fittings
- PVC cement and primer
- A rubber union with hose clamps or a "Y" connector and two (2) check valves depending on the installation method you use
- Six (6) quarts of 1.265 specific gravity battery acid

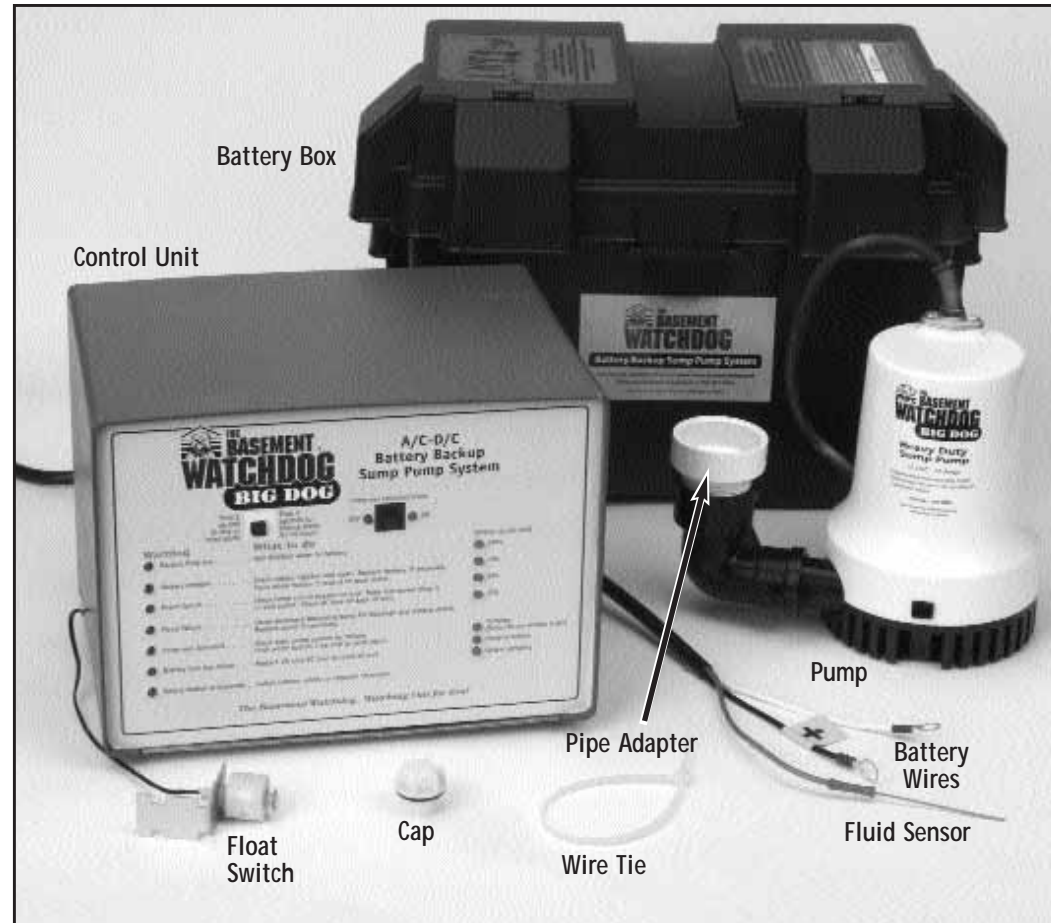

Replacement Parts List

Description	Part No.
Pump	1011003
Float switch assembly	1020003
Fluid sensor assembly	1014001
Pipe Adapter	1120002
Battery Box	1113003
Battery cap with hole	1125000

Call 800-991-0466, option 3 to order parts.

System Specifications

Power supply requirements	115 volts AC
Pumping capacity	3500 GPH @ 0'
Pumping capacity	2200 GPH @ 10'
Pump dimensions	7½" H x 5 ¹³ / ₁₆ " W
Pump dimensions w/elbow	7½" H x 9" W
Pump housing & strainer	Non-corrosive, will not rust
Pump	Can run dry; can be used in sumps with water softener or laundry discharge
Float switch	Independent; can be set at any level

For narrow sump pits you will need some additional parts:

- An "L" bracket at least 6 inches long. (Preferably one that will not rust.)
- Two (2) stainless steel hose clamps
- One (1) stainless steel screw (#8-32 x 3/4"), a matching washer & nut



Pump & Pipe Installation Instructions

There are two basic methods that can be used to install the pump, a direct discharge to the outside of the building, or a connection to an existing discharge pipe. The same two options apply in very narrow sump pits where the backup pump must be mounted above the main pump.

Whenever possible, install your Basement Watchdog backup pump with a direct discharge to the outdoors. By using this method, there will always be an outlet for the water from the sump. During times of very heavy rain, many storm sewers fill up. If your pump is trying to discharge water into a full sewer, there is nowhere for the water to go. By discharging directly outdoors, there is always an outlet for the water that is pumped out of the sump. For this method, you will need to drill a hole through a floor joist or the foundation from the basement to the outside of the house.

If the direct discharge method is not possible or convenient, the Basement Watchdog pump can be hooked up to the same line as your AC sump pump by installing a "Y" connector and two check valves.

In most cases the backup pump will fit next to the main AC pump in the sump pit. In very narrow pits, the backup pump can be mounted above the main pump. Try to fit the backup pump on the floor of the sump first.

Select the installation method that will best suit your needs from the diagrams at the right. Full instructions for each installation method are provided on the following pages.

Installation will take a couple hours.

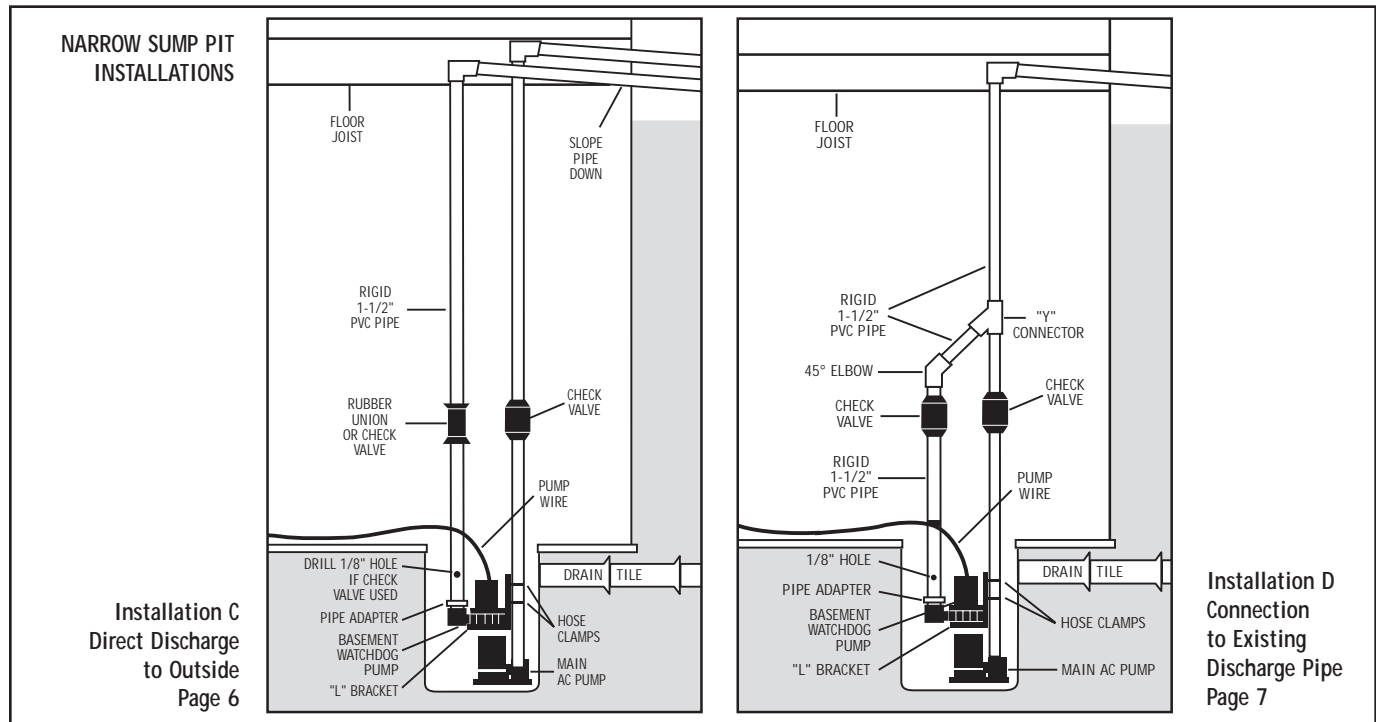
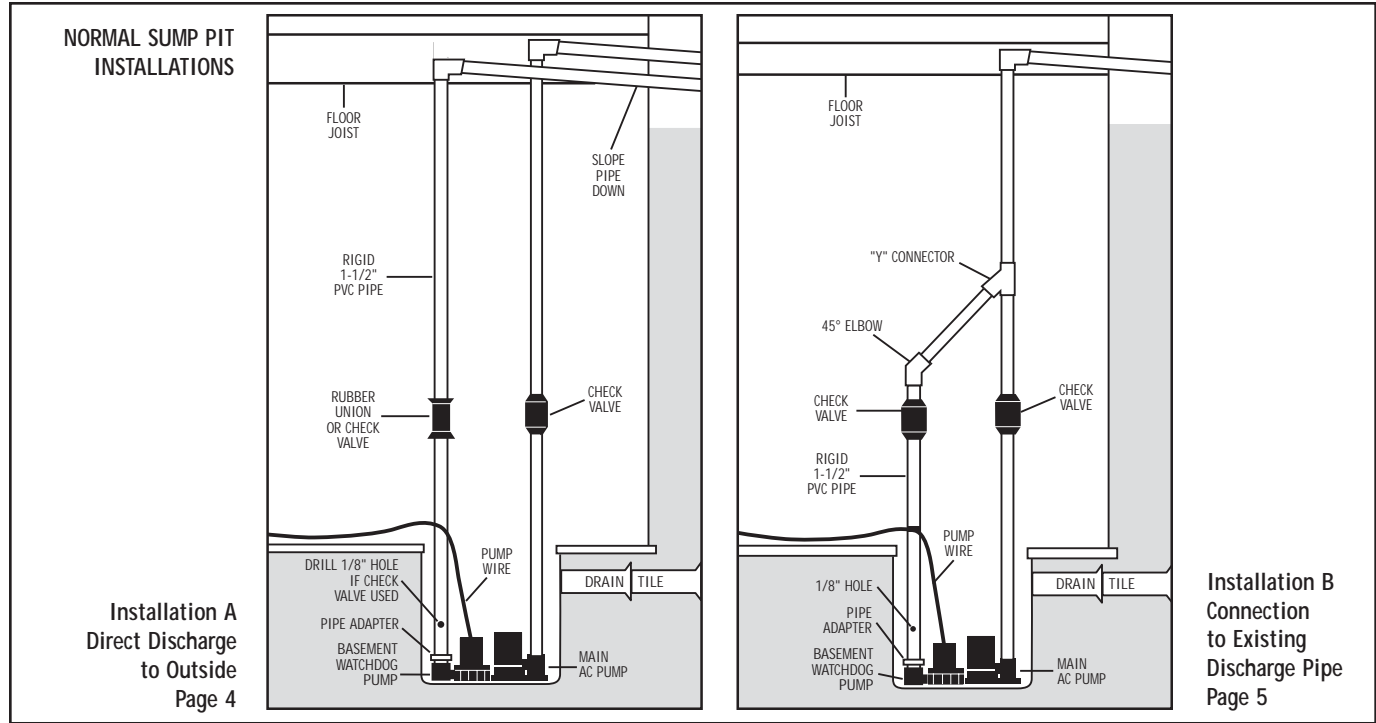

Pump & Pipe Installation Instructions

**INSTALLATION A:
DIRECT DISCHARGE TO THE OUTSIDE OF THE BUILDING (Diagram A)**

⚠ DANGER

Unplug the main AC pump when installing the backup pump to avoid electric shock. Failure to do so could cause serious injury or death.

1. Cut a four-foot (4') piece of 1½" rigid PVC pipe and cement it to the pipe adapter that is attached to the elbow on the pump.
2. Secure the pump wire so that the plug on the end will not fall into the sump. Attach the wire to the pipe with a piece of tape.
3. Place the pump with the 4' PVC pipe attachment on the bottom of the sump floor next to the main AC pump. Do not mount the pump to any existing pipes; it should be placed on the floor of the sump. A brick may

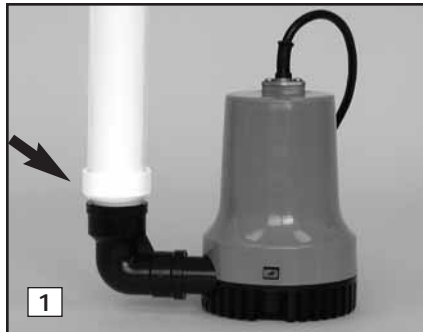

be placed under the pump if there are rocks or other debris on the sump floor that may clog the pump.

4. Attach a rubber union or check valve (sold separately) to the top of the 1½" pipe. This will allow the pump to be removed easily, should the need arise.

The path of the rest of the pipe and the details of each installation will vary. Using sound plumbing practices, try to route the discharge pipe to an exterior wall via the shortest path with the fewest turns. More turns will reduce the pumping capacity. The pipe section exiting the building should be on a downward slope so that the water in the pipe will exit outside instead of returning to the sump. Extend the discharge pipe outside the building as far as possible to avoid the return of discharged water to the sump. *Be sure to seal the hole in the wall where the pipe exits and cement or clamp all connections securely to prevent leaking.* No check valve is needed with this method of installation, as long as you use *less than 20 feet* of pipe.

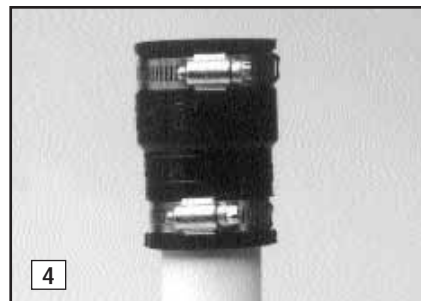

CAUTION

If you use more than a total of 20 feet of pipe in the installation, install a check valve in place of the rubber union. Make sure it is installed with the arrow pointing up or it will not prevent the backflow of water. When a check valve is used, a 1/8" hole must be drilled in the PVC pipe 3" above the Basement Watchdog pump. If a hole is not drilled above the pump, an air lock may prevent the pump from operating, and the basement will flood.

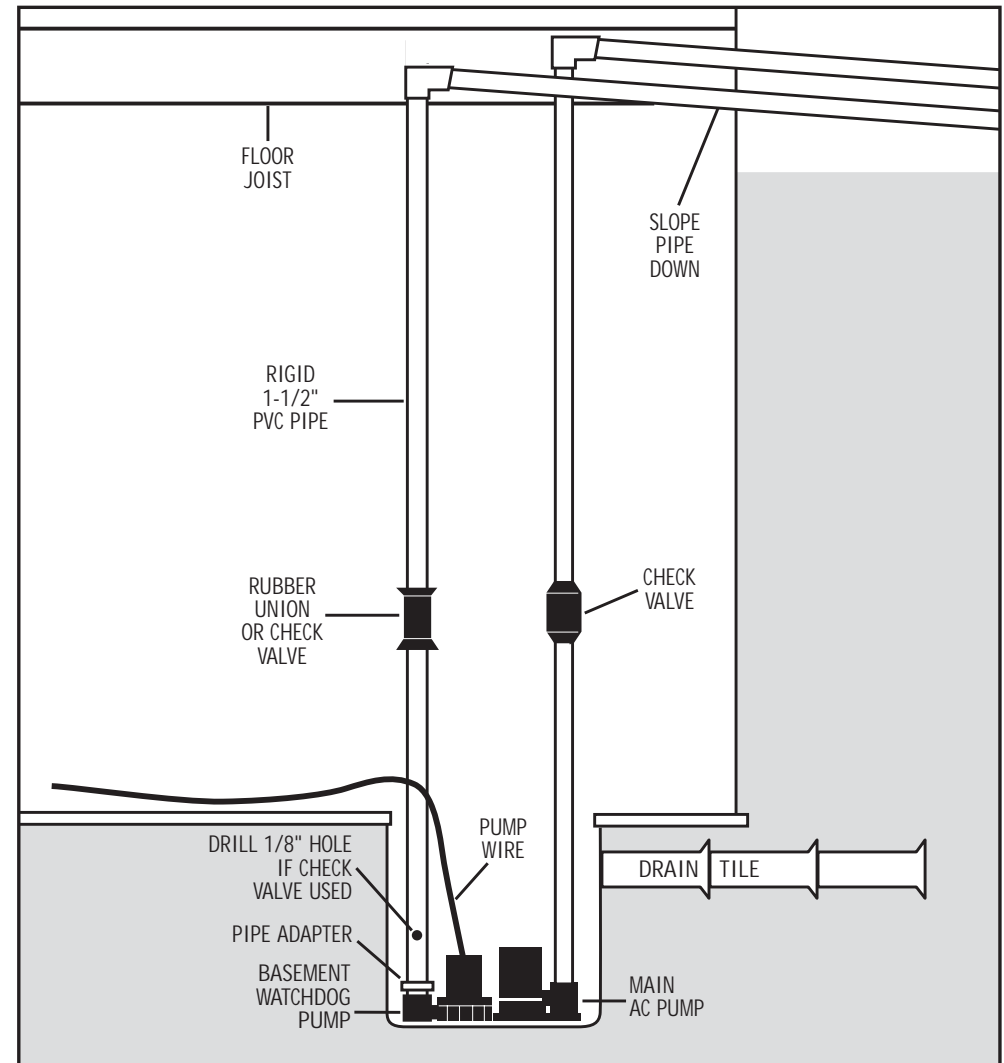
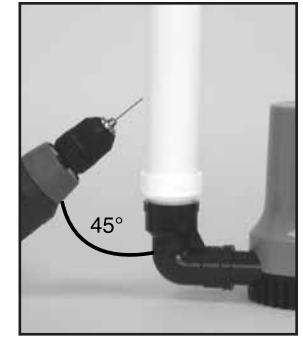
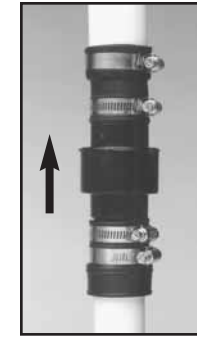

Diagram A

Pump & Pipe Installation Instructions

INSTALLATION B: CONNECTION TO AN EXISTING DISCHARGE PIPE (Diagram B)

⚠ DANGER

Unplug the main AC pump when installing the backup pump to avoid electric shock. Failure to do so could cause serious injury or death.

1. Cut a four-foot (4') piece of 1/2" rigid PVC pipe and cement it to the pipe adapter that is attached to the elbow on the pump.
2. (a) Install a check valve on the PVC pipe attached to the Basement Watchdog pump. Make sure it is installed with the arrow pointing up or it will not prevent the backflow of water.

CAUTION

2. (b) When a check valve is used, drill a 1/8" hole in the 1/2" PVC pipe three inches (3") above the connection to the Basement Watchdog pump. Drill the hole at a 45° angle toward the bottom of the sump to avoid splashing water outside the sump pit. If a 1/8" hole is not drilled above the pump, an air lock may prevent the pump from operating, and the basement will flood.
3. If there is no check valve on the main AC pump, one must be installed at this time.

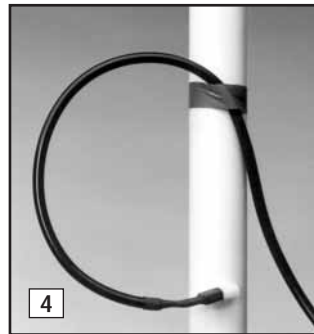
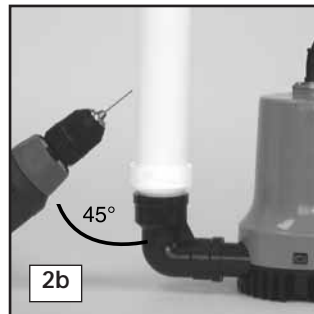
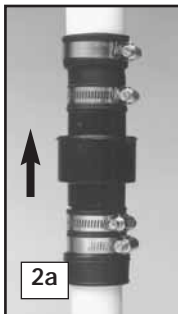

Then install a "Y" connector above the check valve on the discharge pipe for the main AC pump.

4. Secure the pump wire so that the plug on the end will not fall into the sump. Attach the wire to the pipe with a piece of tape.
5. Place the pump with the 4' PVC pipe attachment on the bottom of the sump floor, next to the main AC pump. Do not mount the pump to any existing pipes...it should be placed on the floor of the sump. A brick may be placed under the pump if there are rocks or other debris on the sump floor.
6. Connect a 1/2" diameter discharge pipe above the check valve of the Basement Watchdog pump, and attach a 45° elbow to that pipe. Extend another piece of pipe to reach the "Y" connector you have inserted above the check valve on the discharge pipe of the main AC pump.
7. Cement or clamp all connections securely to prevent leaking.

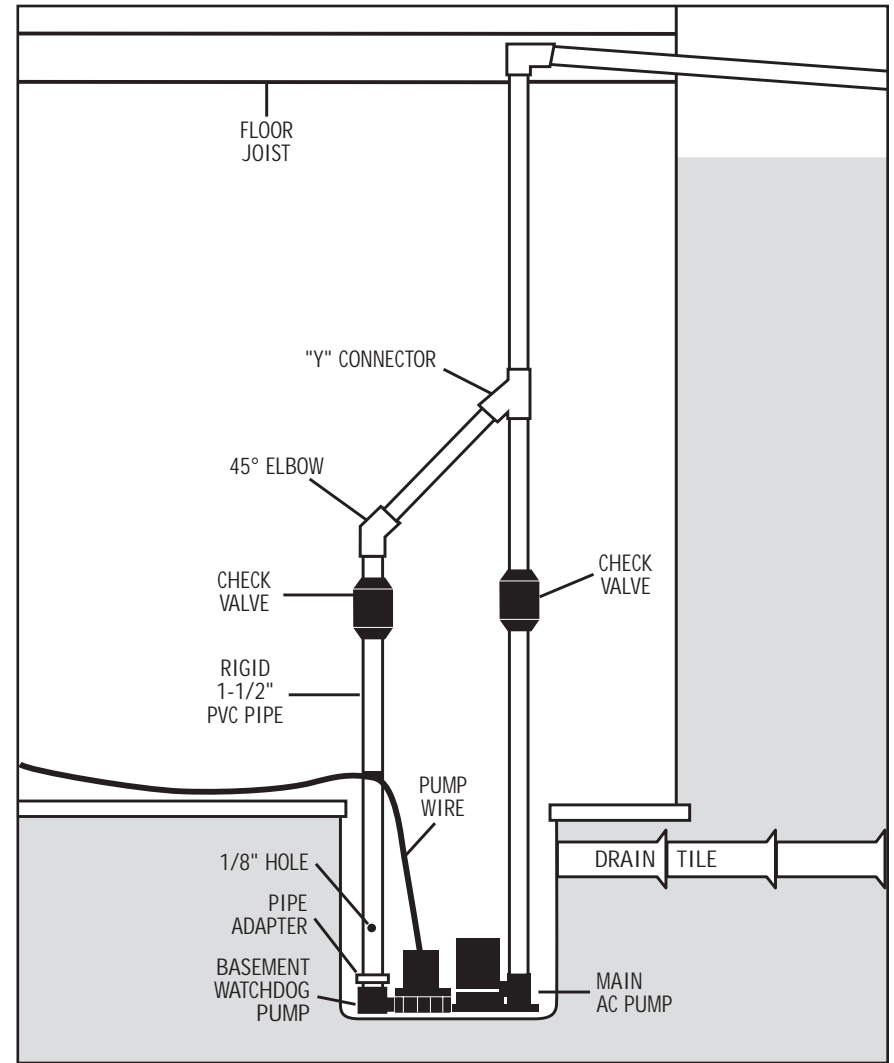
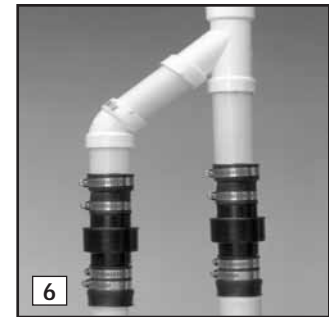

Diagram B

Pump & Pipe Installation Instructions

**INSTALLATION C:
DIRECT DISCHARGE TO THE OUTSIDE OF THE BUILDING FOR NARROW SUMP PITS
(Diagram C)**

⚠ DANGER

Unplug the main AC pump when installing the backup pump to avoid electric shock. Failure to do so could cause serious injury or death.

1. Attach an "L" bracket to the discharge pipe of the main AC pump with two (2) stainless steel hose clamps. Position the bracket so the bottom of the "L" is just above the top of the main pump, and out of the way of any float switch on the main pump.
2. (a) Remove the black bottom strainer of the pump by pressing in the two tabs on the strainer. There are holes suitable for mounting on the bottom of the strainer. (b) Using a #8-32 x 3/4" stainless screw, washer

& nut, attach the strainer to the "L" bracket. (c) Once the strainer is attached, simply press the pump body onto the mounted strainer.

3. Cut a three-foot (3') piece of 1½" rigid PVC pipe and cement it to the pipe adapter that is attached to the elbow on the pump.
4. Secure the pump wire so that the plug on the end will not fall into the sump. Attach the wire to the pipe with a piece of tape.
5. Attach a rubber union or check valve (sold separately) to the top of the 1½" pipe. This will allow the pump to be removed easily, should the need arise.

The path of the rest of the pipe and the details of each installation will vary. Using sound plumbing practices try to route the discharge pipe to an exterior wall via the shortest path with the fewest turns. More turns will reduce the pumping capacity. The pipe section exiting the building should be on a downward slope so that the water in the pipe will exit outside instead of returning to the sump. Extend the discharge pipe outside the building as far as

possible to avoid the return of discharged water to the sump. *Be sure to seal the hole in the wall where the pipe exits and cement or clamp all connections securely to prevent leaking.* No check valve is needed with this method of installation, as long as you use *less than 20 feet* of pipe.

CAUTION

If you use more than a total of 20 feet of pipe in the installation, install a check valve in place of the rubber union. Make sure it is installed with the arrow pointing up or it will not prevent the backflow of water. When a check valve is used, a 1/8" hole must be drilled in the PVC pipe 3" above the Basement Watchdog pump. If a hole is not drilled above the pump an air lock may prevent the pump from operating, and the basement will flood.

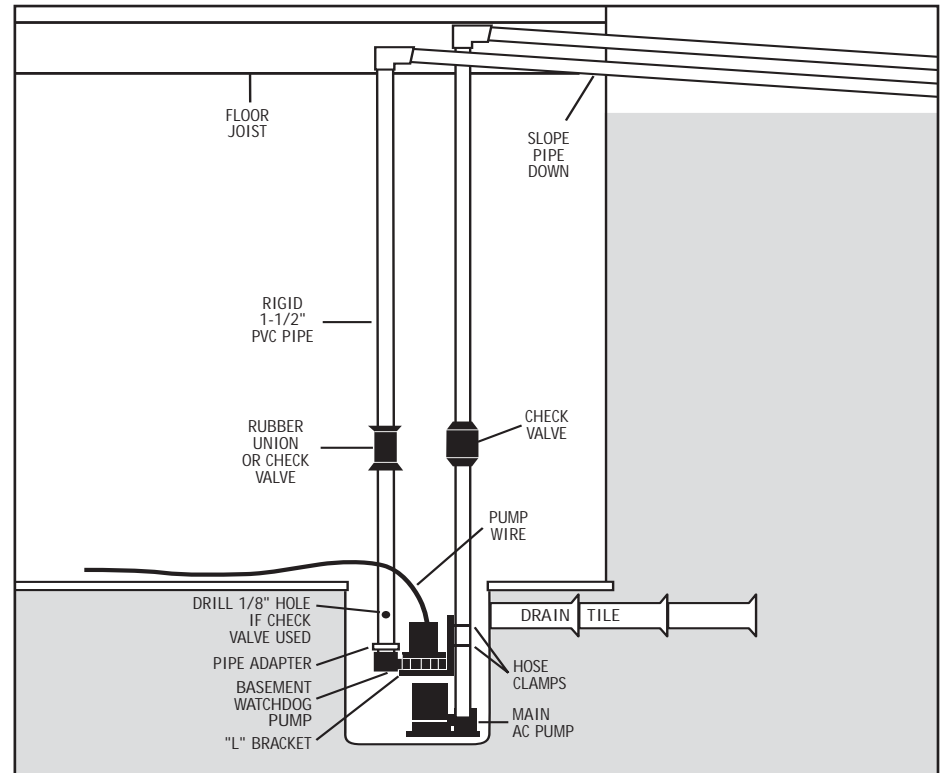
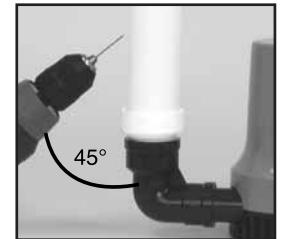
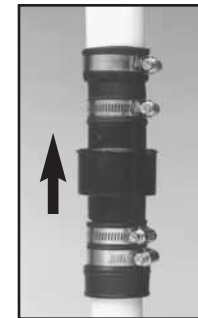
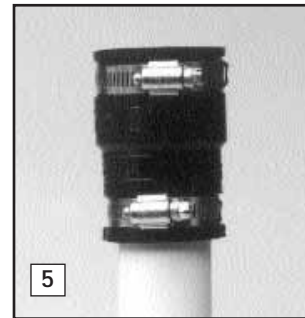
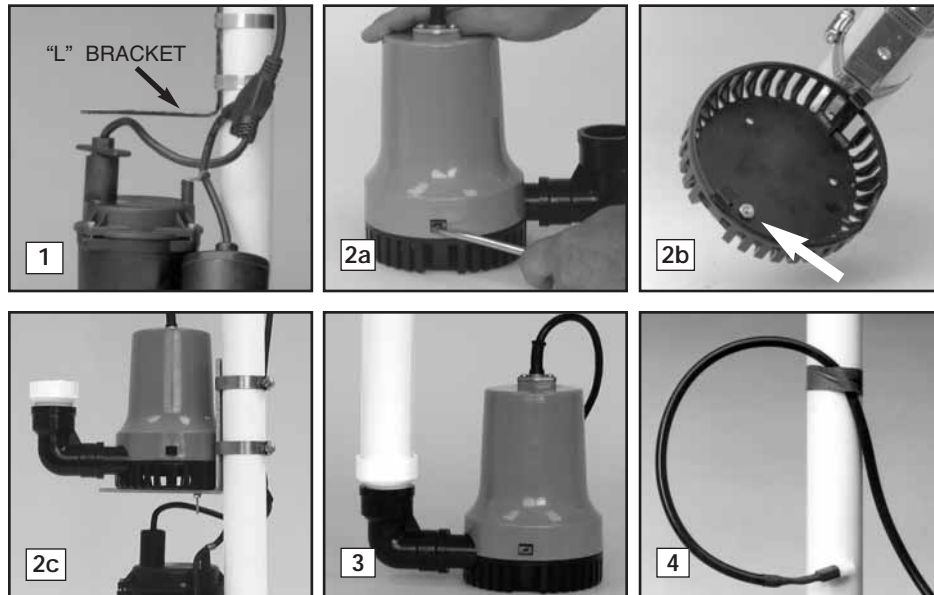

Diagram C

Pump & Pipe Installation Instructions

INSTALLATION D: CONNECTION TO EXISTING DISCHARGE PIPE FOR NARROW SUMP PITS (Diagram D)

⚠ DANGER

Unplug the main AC pump when installing the backup pump to avoid electric shock. Failure to do so could cause serious injury or death.

1. Attach the "L" bracket to the discharge pipe of the main AC pump with two (2) stainless steel hose clamps. Position the bracket so the bottom of the "L" is just above the top of the main pump, and out of the way of any float switch on the main pump.

2. (a) Remove the black bottom strainer of the pump by pressing in the two tabs on the strainer. There are holes suitable for mounting on the bottom of the strainer. (b) Using a #8-32 x 3/4" stainless screw, washer and nut, attach the strainer to the "L" bracket. (c) Once the strainer is attached, simply press the pump body onto the mounted strainer.

3. Cut a three-foot (3') piece of 1 1/2" rigid PVC pipe and cement it to the pipe adapter that is attached to the elbow on the pump.

4. (a) Install a check valve on the PVC pipe attached to the Basement Watchdog pump. Make sure it is installed with the arrow pointing up or it will not prevent the backflow of water.

CAUTION

4. (b) When a check valve is used, drill a 1/8" hole in the 1 1/2" PVC pipe three inches (3") above the connection to the Basement Watchdog pump. Drill the hole at a 45° angle toward the bottom of the sump to avoid splashing water outside the sump pit. If a hole is not drilled above the pump, an air lock may

prevent the pump from operating, and the basement will flood.

5. If there is no check valve on the main AC pump, one must be installed at this time. Then install a "Y" connector above the check valve on the discharge pipe for the main AC pump.

6. Secure the pump wire so that the plug on the end will not fall into the sump. Attach the wire to the pipe with tape.

7. Connect a 1 1/2" diameter discharge pipe above the check valve of the Basement Watchdog pump, and attach a 45° elbow to that pipe. Extend another piece of pipe to reach the "Y" connector you have inserted above the check valve on the discharge pipe of the main pump.

8. Cement or clamp all connections securely to prevent leaking.

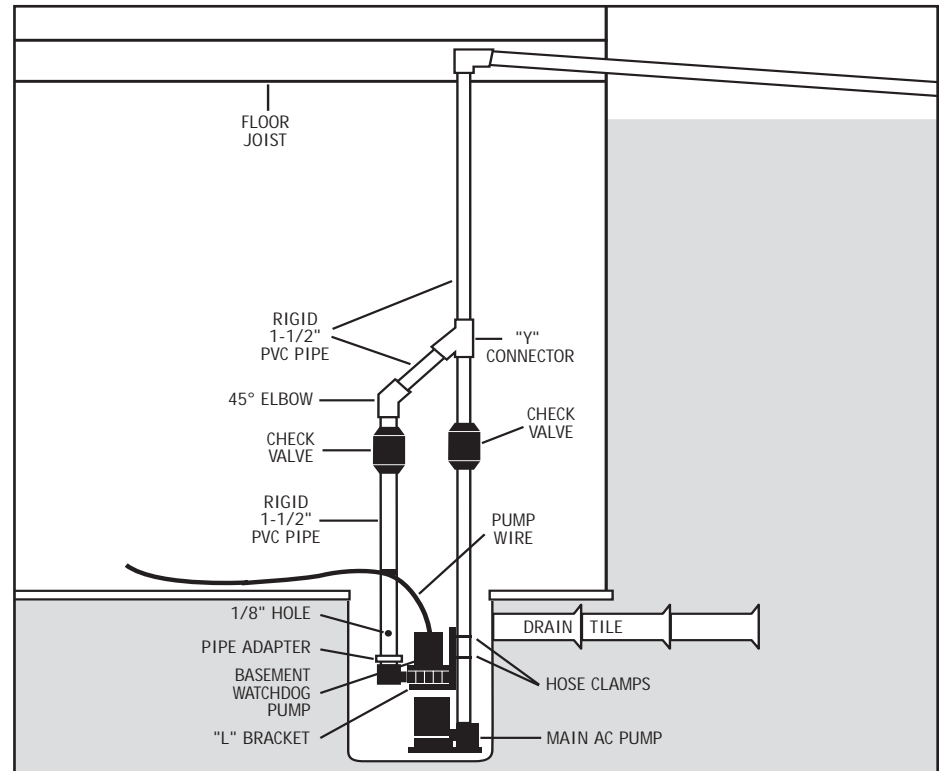
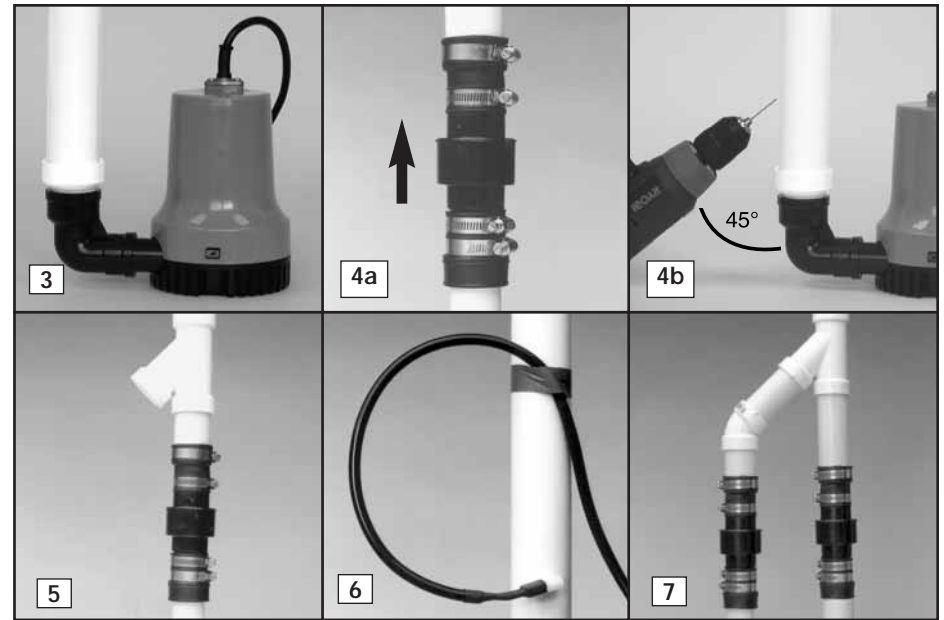
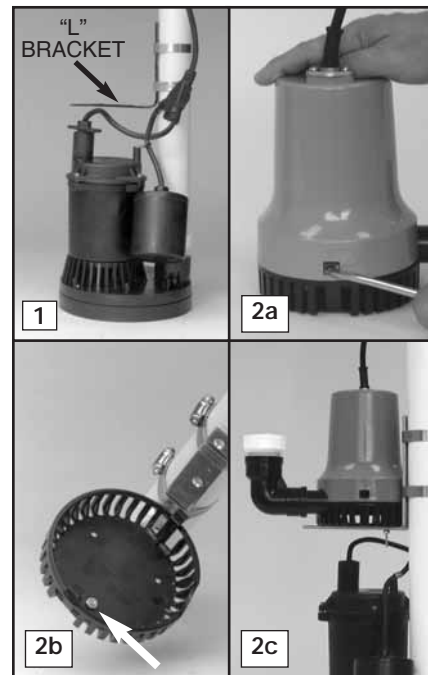

Diagram D

Battery Instructions

A new Basement Watchdog 7.5 Hour Standby Battery will run this system for a minimum of 7.5 hours continuously. However, most of the time the pump will turn on and off, and the battery will run the pump intermittently for days. In addition, the unique materials in the battery enable it to last for five to seven years in standby service.

CAUTION

- The use of automotive batteries is NOT recommended. Automotive batteries are not designed for this application. They will only run the pump for a short time and will have a shorter life than a standby battery.
- The battery fluid sensor and cap are designed to fit the Basement Watchdog batteries. Measuring the battery fluid is one of the most important features of the system; since about 80% of backup sump pump failures are the result of a battery that has dried out.

⚠ DANGER

Do not use the enclosed battery cap on any battery except a Basement Watchdog battery. Do not drill a hole in the cap of another brand of battery to accommodate the fluid sensor. Batteries emit explosive gases, which can cause serious injury or death.

PREPARING THE BASEMENT WATCHDOG STANDBY BATTERY

The Basement Watchdog batteries are shipped dry (without acid) so they never lose power before you take them home. A battery is activated when the acid is added, and then it slowly begins to deteriorate as it ages. By adding the acid just before use, the battery will always be fresh. Use 1.265 specific gravity battery acid to fill the battery. It is available where you purchased the battery.

⚠ DANGER

Wear eye and clothing protection. If battery acid contacts skin or clothing, wash immediately with soap and water. If acid enters eyes, flush with water for 10 minutes and get medical attention. Review the safety instructions on page 1.

1. Remove the battery box top by pushing in the tabs on the front and back of the box and lifting up.
2. Place the battery box on the floor. Place the dry (unfilled) battery into the battery box. Remove the foil seal on the top of the battery.
- 3.(a) Carefully push in the perforated tab at the top of the acid pack. Lift up the large tab and pull out the dispensing hose. Hold the hose upright above the pack and squeeze the hose forcing all the acid back into the pack. (b) Position the acid pack and battery as shown at the right. Pinch the end of the hose together and cut off the tip. Insert the end of the hose into each cell. Control the flow by pinching the hose with thumb and forefinger. **Fill each cell of the battery to a level just covering the battery plates, and then go back and top off each cell equally. It is important to have the cells filled equally or the battery will not operate properly.** The acid should reach a level just below the cap ring. (Diagram E)

A newly filled battery will sometimes require additional acid after about ten minutes. Re-examine the fill level and add additional acid, if necessary. The battery acid may bubble at this time and give off a sulfur-like smell, but this is normal. After the battery has been filled, screw the caps on the top of the battery.

CAUTION

When you fill the battery for the **FIRST** time, it will be the **ONLY** time you add acid to the battery. In the future, when the fluid level is low, add distilled water to the cells. Never add more acid.



Do not throw an old battery in the trash. Take it to a service station or recycling center.

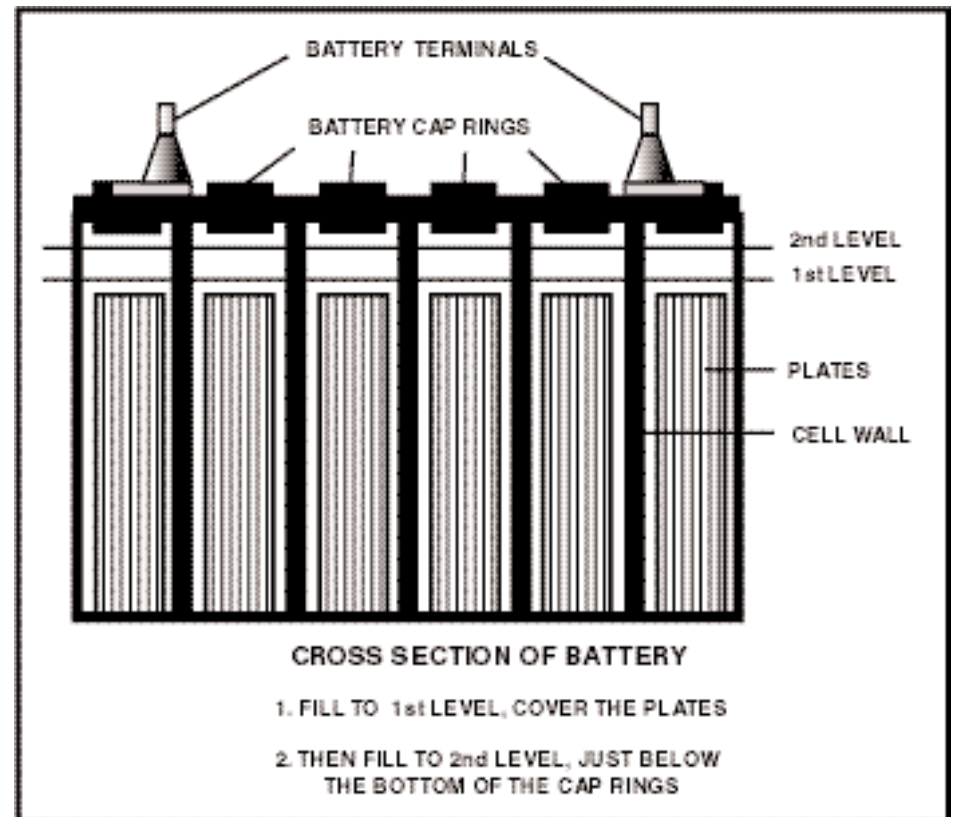
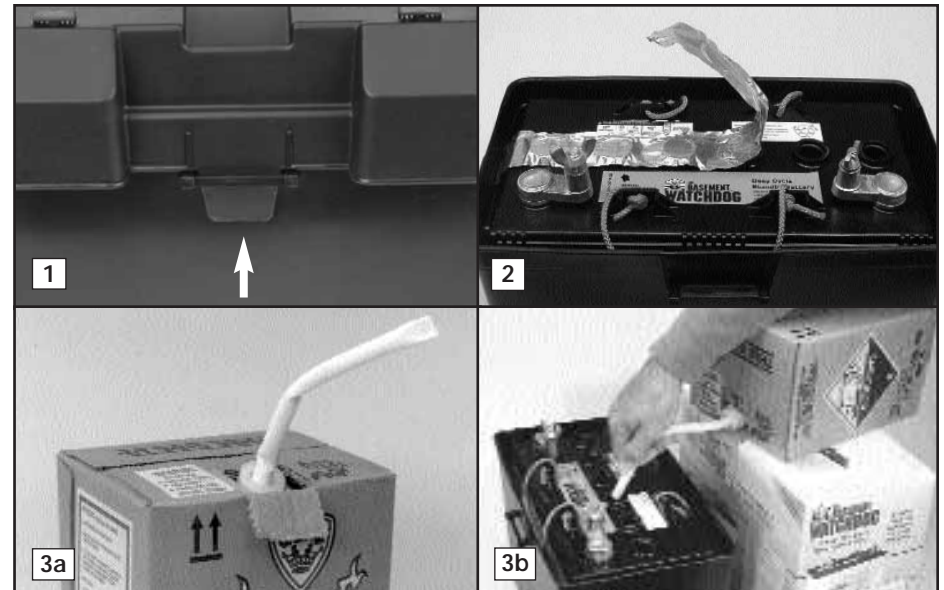

Diagram E

Control Unit Connections

⚠ DANGER

Risk of electrical shock or battery explosion, which can cause serious injury or death. Unplug the main AC pump to avoid electrical shock. Wear eye protection. Work in a well-ventilated area. Do not smoke or allow a spark or flame in the vicinity of the battery. Avoid dropping metal tools on the battery. If battery acid contacts eyes, flush with water for 10 minutes. Review the safety instructions on page 1.

Position the control unit in a secure place approximately 4 feet above the floor. Be sure the power cord will reach the AC power outlet and the pump cable and the float switch will reach the bottom of the sump. Position the unit in a well-ventilated area. Do not place anything on top of the battery. Do not place anything on top of the control unit. (Diagram F)

1. Positioning the float switch: The float switch will turn on the pump when the water rises to the top of the switch, and it will remain running as long as the water is above the float switch. When the water drops below the float switch, an internal timer in the control unit will keep the pump running an additional 25 seconds to empty the sump pit. The switch should be mounted about 6 inches above the water level line in the sump pit. (a) Attach the float switch very securely to the discharge pipe with the plastic wire tie. (b) If the pump is stacked above the main AC pump in a narrow sump pit, the float may be attached to the elbow of the pump. *Be sure the switch is positioned vertically with the mounting bracket at the top. Do not tilt the switch. Do not position the float switch on the side of the discharge pipe facing the drain tile or any incoming rush of water!*

2. Connecting the pump: Remove the security tag from the pump and plug the pump wires into the pump connector on the back of the control unit.

3. Installing the battery fluid sensor: Remove the cover of the battery box by pushing in the tabs on the front and back, then lifting up. Fan the area around the top of the battery with a piece of cardboard (or another non-metallic material) to remove any hydrogen or oxygen gas that may have been emitted from the battery. Replace the battery cap that is 2nd from the POSITIVE (+) post of the battery with the YELLOW battery cap that is provided in the Basement Watchdog package. An arrow on the top of the battery marks this position. There are two holes in the battery cap. Insert the fluid sensor in the hole that is off-center on the top of the cap. *Do not glue the sensor into the cap.*

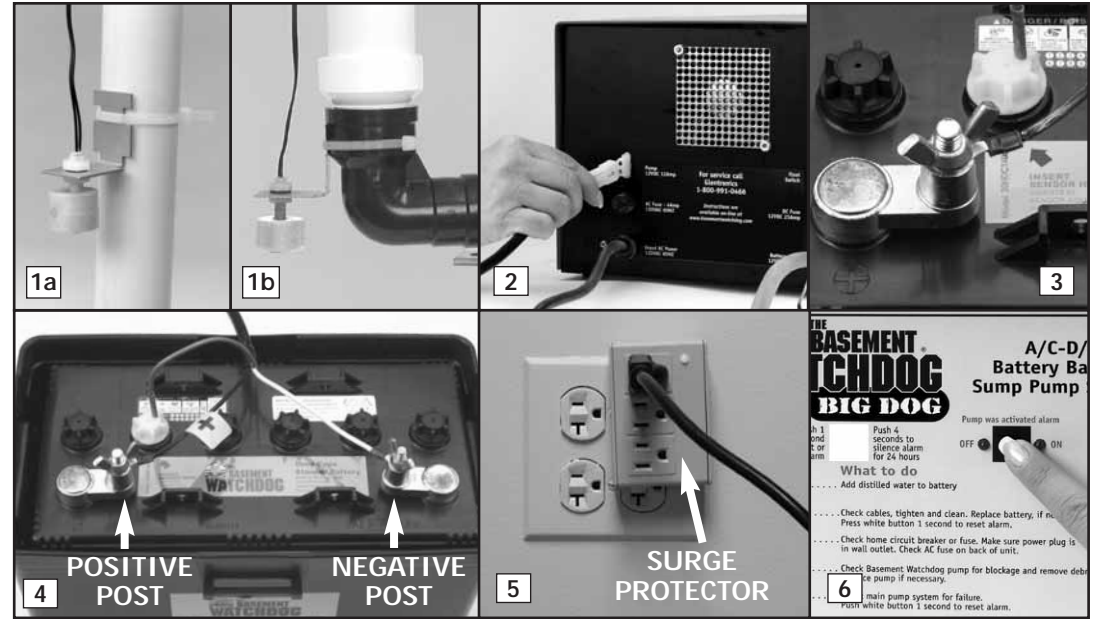

CAUTION

If you are not using the Basement Watchdog battery, you cannot use the battery fluid sensor. However, you must attach the sensor to the POSITIVE (+) post of the battery or the alarm will sound continuously. The Basement Watchdog sump pump system will not warn you if the fluid level is low in this configuration. **You will need to check your battery every couple of months to see if it needs water. If the battery dries out, the system will not work.**

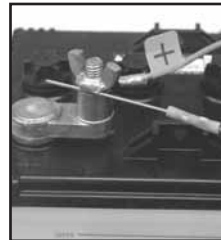

4. Connecting the battery: Remove the wing nuts from the battery terminals. Remove the security tag from the battery cables. Attach the battery cables to the battery...the WHITE wire to the NEGATIVE (-) post, and then the BLACK wire to the POSITIVE (+) post. Replace the wing nuts and tighten.

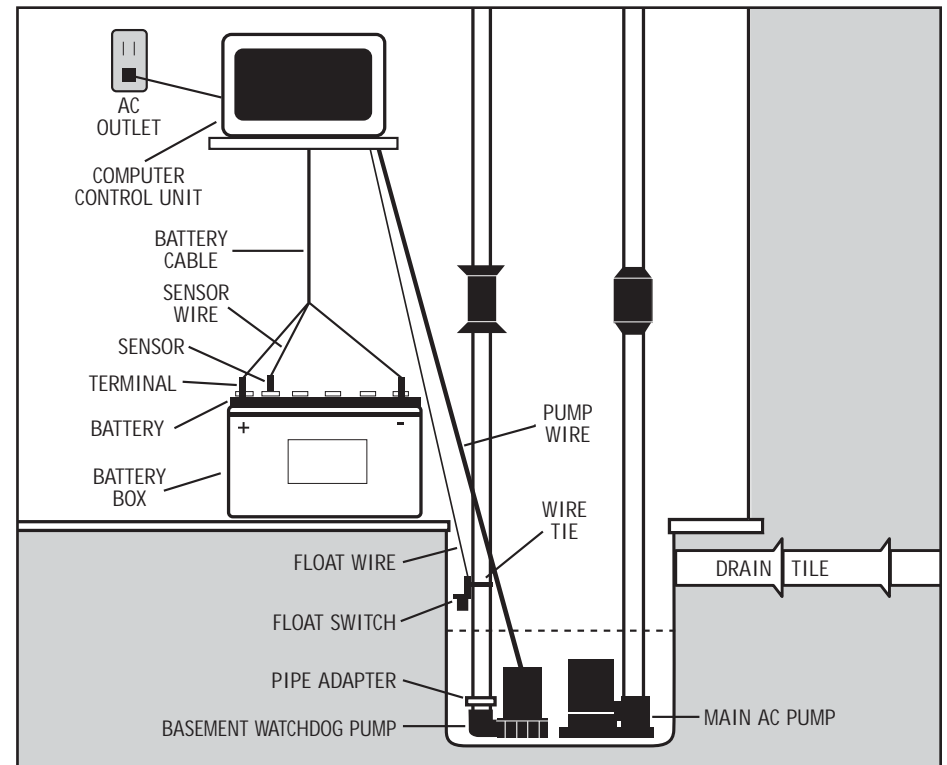

Diagram F

5. Immediately plug the AC power cord into a grounded AC wall outlet. (A surge protector that protects all three pins on the power line is recommended.) You will have 10 seconds before the "Power failure" alarm will sound. The alarm will be silenced once the unit is plugged into the wall. At this time the computer control unit will perform a startup procedure. Various lights will go on and off, the alarm will beep and the pump will be activated for a few seconds.

6. **Selecting the main or backup mode:** The Basement Watchdog Big Dog is designed to be used as a backup to support your main AC pump, however it is strong enough to be used as your main pump. If you are using it as your only pump, push the BLUE button for 1 second to turn off the "Pump was activated" alarm. The RED light to the left of the button will be lit. If you don't turn off the alarm, it will sound every time the pump goes on. Set the level of the float switch 3-4 inches above the pump if you are using it as a main pump.

If you are using the Basement Watchdog as a backup pump along with your main pump, push the blue button for 1 second until the GREEN light is lit. In this mode, the alarm will sound when the backup pump has been activated.

7. Secure the cover on the battery box by slipping the tabs through the fittings on the front and back of the box. **BE SURE TO PLUG IN THE MAIN AC PUMP.**

Understanding the Warnings & Alarms

The Basement Watchdog control unit features a series of warning lights that pinpoint potential problems. In addition, an alarm sounds to alert you to the problem. In some cases the lights and alarm will go off automatically when the problem has been solved. In others, the WHITE button must be pushed to silence the alarm. Refer to the table below for a quick review of the features and their corresponding alarm status.

SILENCING THE ALARM DURING AN EMERGENCY

If the alarm can be silenced before the problem is corrected, you may silence it for two minutes by holding down the WHITE button for 1 second. The alarm will be silenced, but the light will stay on.

To silence the alarm for 24 hours, hold down the WHITE button for 4 seconds. It will automatically reactivate after 24 hours. The warning light will stay on.



Warning	Light	Alarm	Alarm can be silenced before problem is corrected	Alarm shuts off automatically when the problem is corrected
Battery fluid low	Yes	Yes	Yes	Yes
Battery problem	Yes	Yes	No	No, push white button
Power failure	Yes	Yes	Yes	Yes
Pump failure	Yes	Yes	No	No, push white button
Pump was activated	Yes	Yes	Yes	No, push white button
Battery fuse has blown	Yes	Yes	Yes	No, push white button
Battery hooked up backwards	Yes	No	Not applicable	Yes



THE BASEMENT WATCHDOG BIG DOG

A/C-D/C Battery Backup Sump Pump System

Push 1 second to test or reset alarm

Push 4 seconds to silence alarm for 24 hours

Pump was activated alarm

OFF ● ON ●

Warning	What to do	Battery charge level
● Battery fluid low	Add distilled water to battery	● 100%
● Battery problem	Check cables, tighten and clean. Replace battery, if necessary. Press white button 1 second to reset alarm.	● 75%
● Power failure	Check home circuit breaker or fuse. Make sure power plug is in wall outlet. Check AC fuse on back of unit.	● 50%
● Pump failure	Check Basement Watchdog pump for blockage and remove debris. Replace pump if necessary.	● 25%
● Pump was activated	Check main pump system for failure. Push white button 1 second to reset alarm.	● Pumping (Pump can run without water)
● Battery fuse has blown	Replace 25 amp DC fuse on back of unit.	● Charging battery
● Battery hooked up backwards	Switch battery cables to opposite terminals.	● System operating

The Basement Watchdog... Watching Out for You!

BATTERY FLUID IS LOW



Risk of electrical shock or battery explosion, which can cause serious injury or death. Wear eye protection. Work in a well-ventilated area. Do not smoke or allow a spark or flame in the vicinity of the battery. Avoid dropping metal tools on the battery. If battery acid contacts eyes, flush with water for 10 minutes. Review the safety instructions on page 1.

REFER TO THE PHOTOS AT RIGHT & ON PAGE 11

If this warning light and alarm are on, you need to add distilled water to the battery.

1. Remove the top of the battery box by pushing in the tabs on the front and back, then lifting up.
2. Fan the area around the top of the battery with a piece of cardboard (or another non-metallic material) to remove any hydrogen or

oxygen gas that may have been emitted from the battery. Then remove the fluid sensor from the battery cap. The alarm will sound when the sensor is removed.

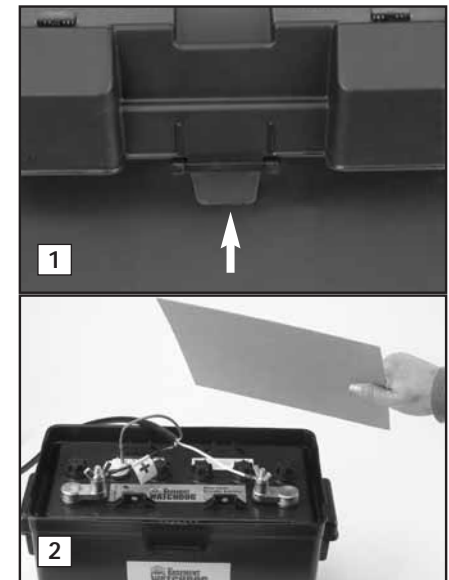



3. Unscrew the six battery caps. Add distilled water to each cell. If distilled water is not available, tap water with a low mineral content may be used. Well water is not recommended. NEVER ADD MORE ACID. Fill the battery to level 2 as shown in Diagram E on page 8. (The Basement Watchdog battery filler will automatically fill the level to the correct height. See enclosed order form.)

4. Replace the battery caps and the fluid sensor. Be sure the fluid sensor is positioned in the 2nd cell from the positive post. It is marked with an arrow on the top of the battery. The warning light and alarm will turn off automatically when the battery is refilled and the sensor is replaced.

5. Replace the battery box cover.

BATTERY PROBLEM

This light and alarm will go on when the control unit senses that the battery has approximately 1 hour of continuous pumping energy left. This could occur when:

- Corrosion on battery terminals and/or cable rings is preventing the battery from charging properly
- The battery is getting old and should be replaced
- The pump has been running for many hours and the battery is below the 25% charge level on the "Battery charge level" gauge

Check the battery cables and the battery terminals for corrosion. Clean and tighten them as needed. The procedure is described at the right.

If the battery alarm goes on while the pump is running and the power is out, you will have a minimum of 1 hour of pumping time to replace the battery. (In most cases, the pump does not run continuously, and therefore, you actually have a longer time to replace it.) You will not be able to silence the alarm. Left unattended, the basement will flood. In a severe emergency, if a replacement battery is not available, you could temporarily use your car battery.

Once the AC power is restored, the battery will recharge automatically, unless it is old or damaged. The alarm will remain on until the WHITE button is pressed for 1 second.

In the event that your Basement Watchdog sump pump system has pumped for an extended period of time, the battery may be very depleted. In this condition, when the AC power is returned to the unit, a battery alarm will continue to sound. The battery may need a longer period to recharge. Press the WHITE button for 4 seconds to silence the alarm.

If the battery is completely discharged, and internal safety feature will not allow the charging system to activate. Call the Glenetronics service department for instructions or replace the battery.

If the battery is relatively new and the battery alarm is activated, before you replace the battery, call the Glenetronics service department. The phone number is 800-991-0466, option 3.

TO CLEAN THE BATTERY TERMINALS AND CABLES

⚠ DANGER

Risk of electrical shock or battery explosion, which can cause serious injury or death. Wear eye protection. Work in a well-ventilated area. Do not smoke or allow a spark or flame in the vicinity of the battery. Avoid dropping metal tools on the battery. If battery acid contacts eyes, flush with water for 10 minutes. Review the safety instructions on page 1.

1. Unplug the power cord from the wall outlet.
2. Remove the cover of the battery box by pushing in the tabs on the front and back, then lifting up.
3. Fan the area around the top of the battery with a piece of cardboard (or another non-

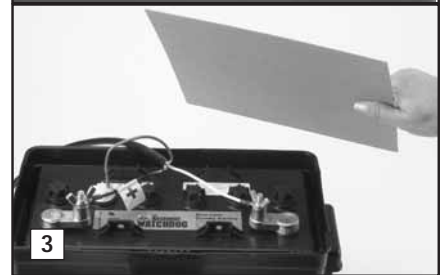
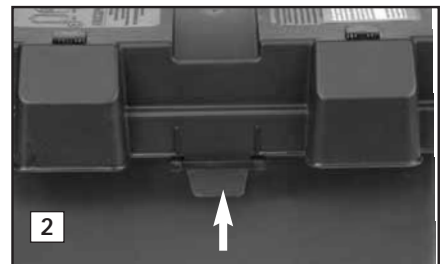

metallic material) to remove any hydrogen or oxygen gas that may have been emitted from the battery.

4. Unscrew the wing nuts. Remove the battery cables and clean the battery posts with a battery post terminal cleaner or a wire brush.
5. Clean the corrosion off of the ring connectors on the ends of the battery wires. Use a stiff brush or sandpaper.
6. If the fluid sensor has come out of the YELLOW battery cap, replace it now. Then replace the battery cables, WHITE to the NEGATIVE (-) post, and BLACK to the POSITIVE (+) post. Tighten the wing nuts.
7. Plug the power cord into the wall outlet. (You can provide additional protection for the control unit by using a surge protector.)

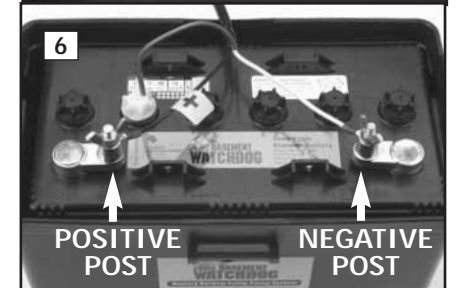

REPLACING THE BATTERY

▲ DANGER

Risk of electric shock or battery explosion, which can cause serious injury or death. Wear eye protection. Work in a well-ventilated area. Do not smoke or allow a spark or flame in the vicinity of the battery. Avoid dropping metal tools on the battery. If battery acid contacts eyes, flush with water for 10 minutes. Review the safety instructions on page 1.

REFER TO THE PHOTOS BELOW

1. Unplug the power cord from the wall outlet.
2. Remove the cover of the battery box by pushing in the tabs on the front and back, then lifting up.

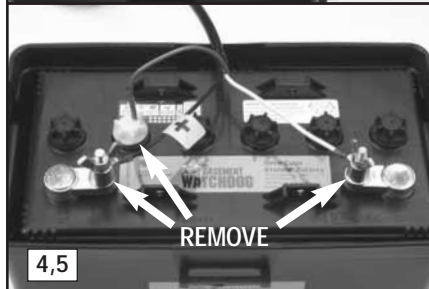
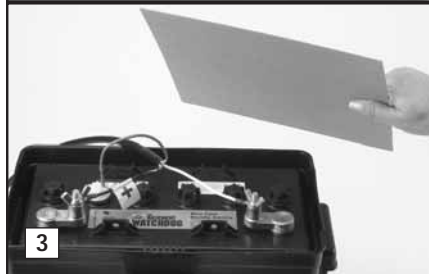
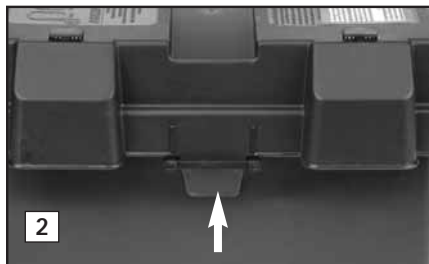

3. Fan the area around the top of the battery with a piece of cardboard (or another non-metallic material) to remove any hydrogen or oxygen gas that may have been emitted from the battery.
4. Remove the fluid sensor from the battery cap, and then remove the YELLOW battery cap. Save it for use in the new battery.
5. Unscrew the wing nuts and remove the battery cables.
6. Remove the old battery from the battery box and place the new battery in the box. Fill the battery following the instructions on page 8.
7. Clean any corrosion off of the ring connectors on the end of the battery cables. Use a wire brush or sandpaper.

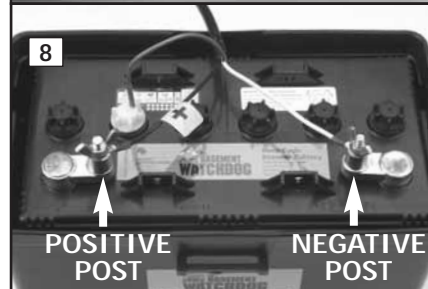

8. Replace the battery cables, WHITE to the NEGATIVE (-) post and BLACK to the POSITIVE (+) post.
9. Rinse and dry the YELLOW cap from the old battery to remove any residue. Replace the BLACK battery cap in the cell that is 2nd from the POSITIVE post with the YELLOW cap from the old battery. Insert the fluid sensor in the cap. Put the BLACK battery cap on the old battery.
10. Plug the power cord into the wall outlet. (You can provide additional protection for the control unit by using a surge protector.)

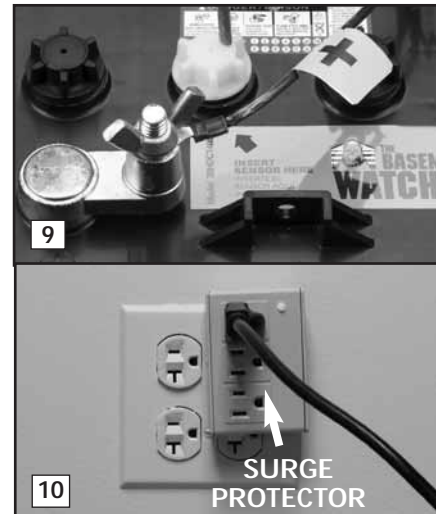

POWER FAILURE

There are several causes for power failure. The most common is a power outage by your electric company. During this emergency, the Basement Watchdog system will automatically switch to battery power and protect your basement from flooding. You can silence the "Power failure" alarm for 24 hours by pressing the WHITE button for 4 seconds. The alarm will be silenced, but the light will stay on. The system will continue to operate while the power alarm is silenced. After 24 hours, the alarm will automatically reactivate.

1. If the power is on in the rest of the house, check the home circuit breaker or fuse box for failure, and correct the problem.
2. Check the power cord. Make sure it is securely plugged into the wall outlet.
3. Check the AC fuse located on the back panel of the control unit. If it has blown, replace it with a 5-amp glass barrel fuse, commonly found at hardware stores and auto supply stores. If the fuse blows again, call Glenetronics technical support at 800-991-0466, option 3.

The control unit must receive 115 volts AC +/- 5% from the AC outlet. Any voltage lower than 110 volts will activate the power failure alarm. Lower voltages can be caused by utility brown outs or a heavy power draw from other appliances on the same circuit.

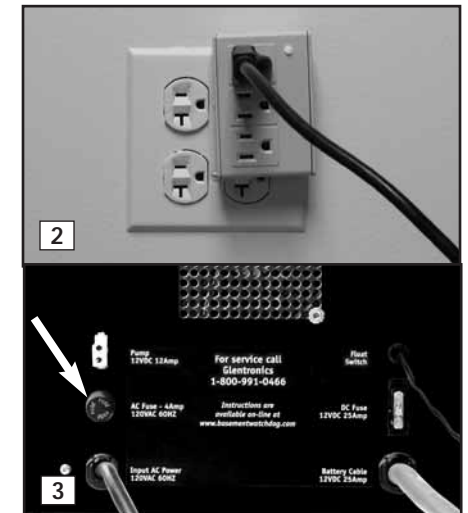

PUMP FAILURE

The Basement Watchdog control unit will check the pump and its wire connections each week for possible pump failure. The system will test the pump by running it for 2-3 seconds to make sure it is operating. If the "Pump failure" alarm sounds:

1. Check the pump plug in the back of the unit to make sure it is firmly connected. Check the pump wires for any possible breaks.
2. If the pump wires are connected, test the pump by lifting the float switch in the sump. It should turn on when the float is lifted. Do not push the WHITE button to test the pump during this procedure. The pump is designed to run dry, so if there is no water in the sump pit during the test, the pump will not be damaged.
3. If the control unit still indicates that the pump is defective, replace the pump. The procedure is described in the next column.

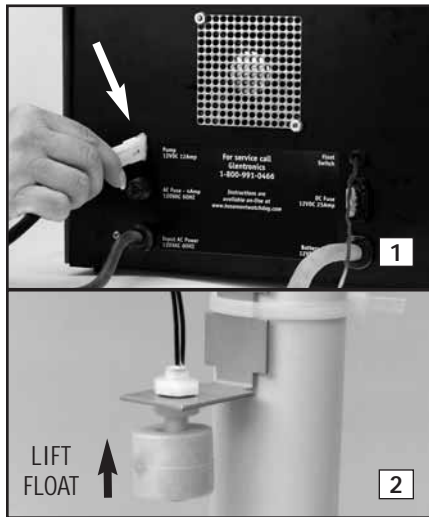

PUMP WAS ACTIVATED

When the water rises in the sump pit and lifts the float switch, the pump will begin pumping, and the "Pump was activated" light and alarm will turn on. The pump warning stays on to alert you to the fact that the standby system was used to empty the water from the sump. Try to determine what caused the system to activate.

- Check the main pump for failure. It may not be working, the float switch may be stuck, or it may be too small to handle the inflow of water.

- Make sure the check valve is working and installed correctly. It may need to be replaced.
- Make sure the discharge pipe is not clogged or frozen.
- If the power was out, and the backup pump was activated, you need to push the WHITE button to silence the alarm

REPLACING THE PUMP

⚠ DANGER

Unplug the main AC pump when installing the backup pump to avoid electric shock. Failure to do so could cause serious injury or death. Review the safety instructions on page 1.

REFER TO PHOTOS BELOW

1. Unplug the pump from the back of the control unit.
2. Release the rubber union or check valve and remove the pump and the rigid PVC pipe section from the sump pit.
3. Unscrew the pipe and fitting from the old pump, and screw them into the new pump.

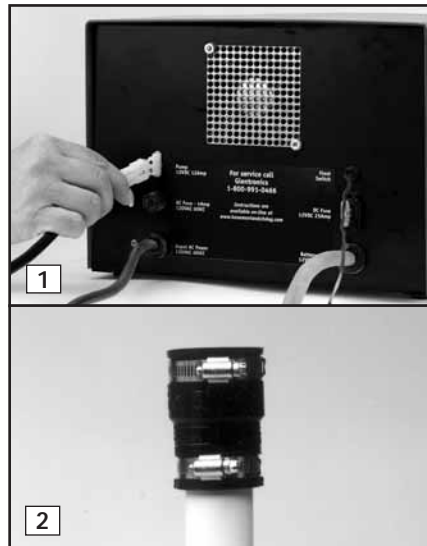

4. Lower the pump into the sump and reconnect the rubber union or check valve.
5. Plug the pump wires into the back of the control panel. **BE SURE TO PLUG IN THE MAIN AC PUMP.**

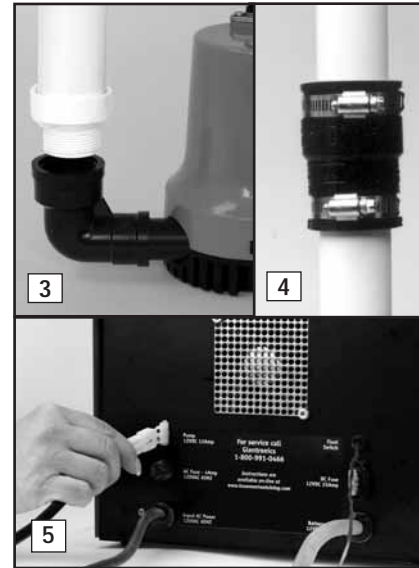

BATTERY FUSE HAS BLOWN

Your Basement Watchdog has a 25-amp DC safety fuse in the back of the cabinet to protect the unit and the battery. If the fuse blows, the alarm will sound to alert you to the problem. Replace the 25-amp fuse. If it blows again, unplug the computer control unit from the wall and disconnect the battery cables from the battery. Then call Glentronics' service department for instructions.

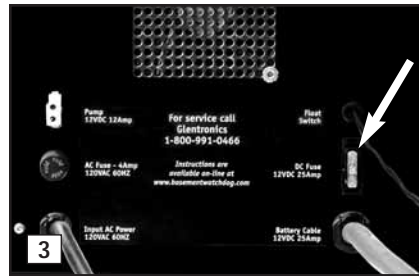

BATTERY HOOKED-UP BACKWARDS

If the battery cables have been connected to the wrong posts, this warning light will go on. No audible alarm will sound, but the unit will not operate. Your Basement Watchdog will protect itself from damage. Reverse the battery cable connections and continue with the system hook-up.



BATTERY CHARGE LEVEL

Your Basement Watchdog backup sump pump system has a gauge which will report the level of charge in the battery. As the battery's energy is depleted during operation without AC power, or simply by aging, the gauge will indicate the percent of charge remaining in the battery. Should the percent drop below 25%, the "Battery problem" indicator will light up and the alarm will sound.

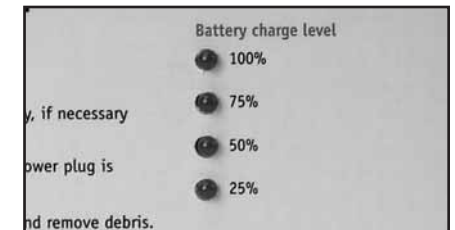

If this warning goes on while the pump is running, you will have a minimum of 1 hour to replace the battery. (In most cases the pump does not run continuously, and therefore, it will run much longer.) In a severe emergency, if a replacement battery is not available, you could temporarily use your car battery.

Once the AC power is restored, the battery will recharge, unless it is old or damaged. Press the WHITE button for 1 second to reset the alarm.

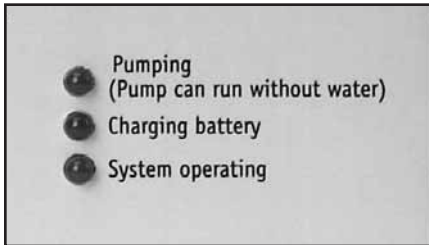

PUMPING

This light will go on when the pump is operating. If the "Pump was activated" alarm switch is OFF, no alarm will sound. This is a normal function of the system.

CHARGING BATTERY

This GREEN light goes on when the battery is charging. The Basement Watchdog has a state-of-the-art 20-amp charging system. It only operates when the battery needs charging and turns off completely when not in use. This will increase the total life of the battery and keep the battery at full charge.

SYSTEM OPERATING

This GREEN light is the "Watchdog" of the system. Normally, this light is on. If the light is off, there is a problem with the system. Contact the Glentronics service department at 800-991-0466, option 3.

TESTING THE FLOAT SWITCH

It is important to manually test the float switch periodically.

Lift the float up and let go. This will activate the pump. The control unit will run the pump for approximately 25 seconds so it can empty all the water in the sump pit. If there is no water in the pit, the pump can run dry for this amount of time. The alarm will sound and the "Pump was activated" light will go on. After the pump has stopped, push the WHITE button to silence the alarm. If the WHITE button is pressed before the pump has stopped, the alarm will go off temporarily. Wait for the pump to stop pumping, and then push the WHITE button to completely silence the alarm.

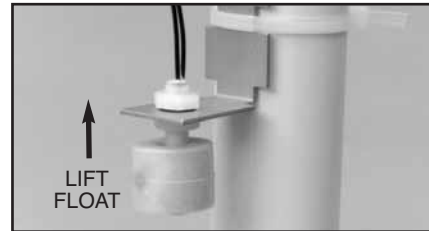

PARTS & SERVICE INFORMATION

You can receive technical support, parts or service information by calling Glentronics, Inc. at 800-991-0466, option 3, or by visiting the website at www.basementwatchdog.com. Send your unit to the following address for repairs:

Glentronics, Inc.
640 Heathrow Drive
Lincolnshire, IL 60069

Limited Warranty

GLETRONICS, INC. warrants to the original retail purchaser that all of its pump, switch, sensor, battery box and control unit products are free from defective materials and workmanship for the period indicated below:

All parts and labor (excluding installation) for a period of two (2) years from the date of purchase

The defective product must be returned directly to the factory, postage prepaid with the original bill of sale or receipt to the address listed below. Glentronics, Inc., at its option, will either repair or replace the product and return it postage prepaid.

CONDITIONS

The unit must be shipped freight prepaid, or delivered, to Glentronics, Inc. to provide the services described hereunder in either its original carton and inserts, or a similar package affording an equal degree of protection.

The unit must not have been previously altered, repaired or serviced by anyone other than Glentronics, Inc., or its agent; the serial number on the unit must not have been altered or removed; the unit must not have been subject to accident, misuse, abuse or operated contrary to the instructions contained in the accompanying manual.

The dealer's dated bill of sale, or retailer's receipt, must be retained as evidence of the date of purchase and to establish warranty eligibility.

This warranty does not cover product problems resulting from handling liquids hotter than 120 degrees Fahrenheit, handling inflammable liquids, solvents, strong chemicals or severe abrasive solutions; normal wear; user abuse; misuse, neglect, improper maintenance, commercial or industrial use; improper connections or installation; damages caused by lightning strikes, excessive surges in AC line voltage, water damage to the controller, other acts of nature, or failure to operate in accordance with the enclosed written instructions.

GLETRONICS, INC. WILL NOT BE LIABLE FOR ANY INCIDENTAL, SPECIAL OR CONSEQUENTIAL DAMAGES FOR BREACH OF ANY EXPRESS OR IMPLIED WARRANTIES ON THIS PRODUCT. SOME STATES DO NOT ALLOW THE EXCLUSION OR LIMITATION OF CONSEQUENTIAL OR INDIRECT DAMAGES, SO THE ABOVE LIMITATION MAY NOT APPLY TO YOU. THIS EXPRESS WARRANTY SHALL BE EXCLUSIVE AND IS IN LIEU OF ALL OTHER WARRANTIES, WRITTEN OR ORAL, EXPRESS OR IMPLIED, INCLUDING, BUT NOT LIMITED TO ANY WARRANTY OF MERCHANTABILITY OR FITNESS FOR A PARTICULAR PURPOSE. THE CUSTOMER'S EXCLUSIVE REMEDY FOR BREACH OF THIS WARRANTY, OR OF ANY IMPLIED WARRANTY NOT EXCLUDED HEREIN, SHALL BE LIMITED TO REPAIR OR REPLACEMENT OF THE PRODUCT.

For information or service contact:

Glentronics, Inc.
640 Heathrow Drive
Lincolnshire, IL 60069
800-991-0466

Model # BWD12-120C Serial # _____ Purchase Date _____

Troubleshooting Guide

⚠ DANGER Read safety warnings & instructions before attempting any repairs or maintenance.

BATTERY FLUID LOW

Possible Reasons	Remedies
The battery fluid is low	Add distilled water to the battery

BATTERY PROBLEM

Possible Reasons	Remedies
Terminals are corroded	Clean terminals & cables
Cables are loose	Tighten wing nuts
Battery is discharged below 25%	Replace battery if power is out. There is only 1 hour of continuous pumping power left. Battery will recharge when power is restored
Battery is damaged or old	Replace battery

POWER FAILURE

Possible Reasons	Remedies
Power outage	None. The backup pump will run on the battery
An outlet, fuse or circuit breaker has failed	Try another outlet, replace the fuse or reset the circuit breaker
The power cord is unplugged from the wall	Make sure the power cord is plugged in securely
The charger is receiving less than 110 volts from the outlet	None, if the utility company has instigated brown outs. Otherwise, reduce the number of other appliances on the circuit

PUMP FAILURE

Possible Reasons	Remedies
Backup pump is unplugged	Make sure the pump is securely plugged into the back of the control unit
Backup pump is broken	Replace the pump
Backup pump is clogged	Remove strainer and clean out any debris

PUMP WAS ACTIVATED

Possible Reasons	Remedies
The main AC pump failed because of a power outage	None. The backup pump was activated
The main AC pump is broken	Replace the main AC pump
The float switch on the main pump is jammed or defective	Free the float switch or replace it
The main AC pump could not keep up with the inflow of water	None. The backup pump was activated. If this is a recurring problem, install a higher capacity main pump
The check valve is stuck or installed improperly and the water returns to the sump pit	Replace the check valve or correct the installation
The discharge pipe is blocked and the water returns to the sump pit	Clean out or replace the discharge pipe

BATTERY FUSE HAS BLOWN

Possible Reasons	Remedies
Pump is clogged	Remove pump and strainer. Clean out any debris. Replace the 25-amp DC fuse
Pump wires are exposed	Replace the pump
Pump is broken	Replace the pump

BATTERY HOOKED UP BACKWARDS

Possible Reasons	Remedies
The unit will not operate	Reverse the battery connections