

**IMPORTANT!
WARRANTY REGISTRATION**

Your product is covered by the enclosed Warranty.
To complete the Warranty Registration Form go to:

<http://www.cranepumps.com/ProductRegistration/>

If you have a claim under the provision of the warranty, contact your local
Crane Pumps & Systems, Inc. Distributor.

RETURNED GOODS

**RETURN OF MERCHANDISE REQUIRES A "RETURNED GOODS AUTHORIZATION".
CONTACT YOUR LOCAL CRANE PUMPS & SYSTEMS, INC. DISTRIBUTOR.**



Products Returned **Must** Be Cleaned, Sanitized,
Or Decontaminated As Necessary Prior To Shipment,
To Insure That Employees Will Not Be Exposed To Health
Hazards In Handling Said Material. All Applicable Laws
And Regulations Shall Apply.

BARNES®

INSTALLATION MANUAL Submersible Sump Pump

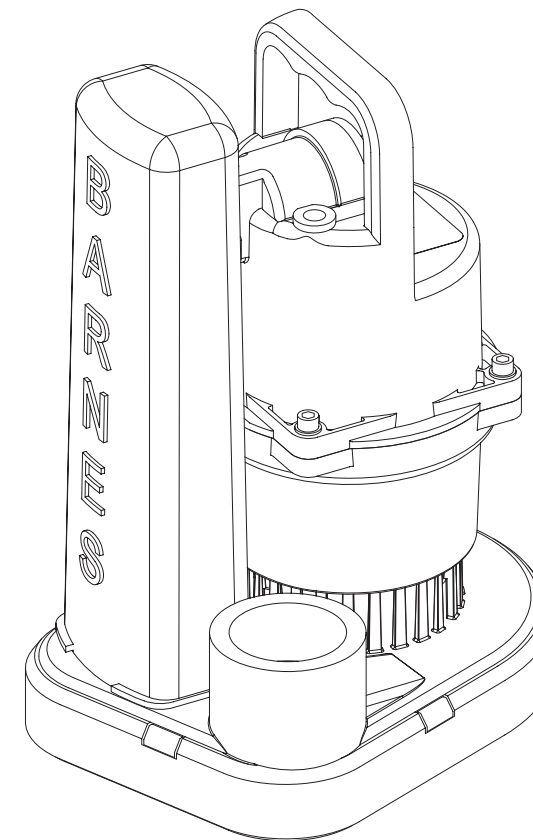

Series: SU33
120 Volts, 1 Phase, 60 Hz
1½" NPT, Female, Vertical
104°F (40°C) Continuous

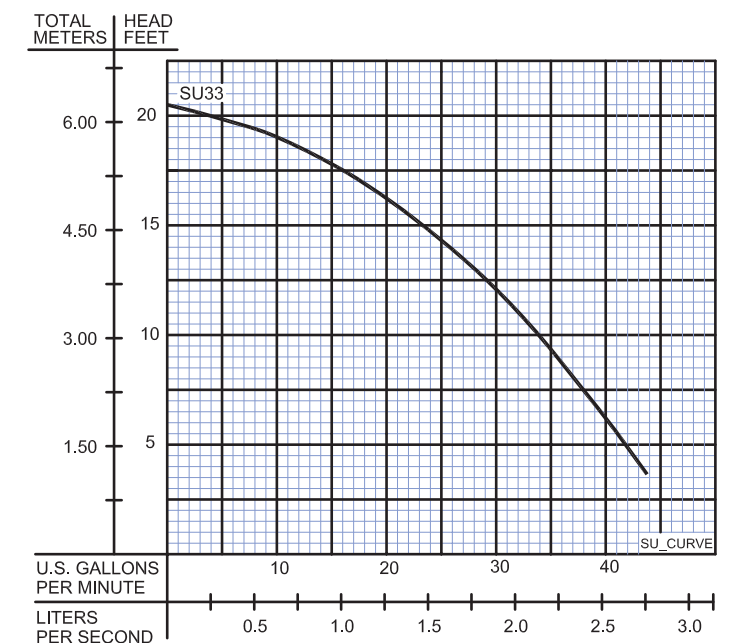

This product may be covered by one or more of
the following patents and other patent(s) pending:
US Patent 8,167,578

IMPORTANT!

*Read all instructions in this manual before operating pump.
As a result of Crane Pumps & Systems, Inc., constant product improvement program,
product changes may occur. As such Crane Pumps & Systems reserves the right to
change product without prior written notification.*

CRANE

A Crane Co. Company

PUMPS & SYSTEMS

420 Third Street
Piqua, Ohio 45356
Phone: (937) 778-8947
Fax: (937) 773-7157
www.cranepumps.com

83 West Drive, Brampton
Ontario, Canada L6T 2J6
Phone: (905) 457-6223
Fax: (905) 457-2650



Form No. 129937-Rev. D







SAFETY FIRST!

Please Read This Before Installing Or Operating Pump. This information is provided for **SAFETY** and to **PREVENT EQUIPMENT PROBLEMS**. To help recognize this information, observe the following symbols:

IMPORTANT! Warns about hazards that can result in personal injury or Indicates factors concerned with assembly, installation, operation, or maintenance which could result in damage to the machine or equipment if ignored.

CAUTION! Warns about hazards that can or will cause minor personal injury or property damage if ignored. Used with symbols below.

WARNING! Warns about hazards that can or will cause serious personal injury, death, or major property damage if ignored. Used with symbols below.

 Hazardous fluids can cause fire or explosions, burns or death could result.	 Extremely hot - Severe burns can occur on contact.
 Biohazard can cause serious personal injury.	 Hazardous fluids can Hazardous pressure, eruptions or explosions could cause personal injury or property damage.
 Rotating machinery Amputation or severe laceration can result.	 Hazardous volt- age can shock, burn or cause death.

Only qualified personnel should install, operate and repair pump. Any wiring of pumps should be performed by a qualified electrician.

WARNING! To reduce risk of electrical shock, pumps and control panels must be properly grounded in accordance with the National Electric Code (NEC) or the Canadian Electrical Code (CEC) and all applicable state, province, local codes and ordinances. Improper grounding voids warranty.

WARNING! To reduce risk of electrical shock, always disconnect the pump from the power source before handling or servicing. Lock out power and tag.

WARNING! Operation against a closed discharge valve will cause premature bearing and seal failure on any pump, and on end suction and self priming pump the heat build may cause the generation of steam with resulting dangerous pressures. It is recommended that a high case temperature switch or pressure relief valve be installed on the pump body.

CAUTION! Never operate a pump with a plug-in type power cord without a ground fault circuit interrupter.

CAUTION! Pumps build up heat and pressure during operation-allow time for pumps to cool before handling or servicing.

 **WARNING!** Do not pump hazardous materials (flammable, caustic, etc.) unless the pump is specifically designed and designated to handle them.

 **CAUTION!** Do not block or restrict discharge hose, as discharge hose may whip under pressure.

 **WARNING!** Do not wear loose clothing that may become entangled in moving parts.

 **WARNING!** Keep clear of suction and discharge openings. **DO NOT** insert fingers in pump with power connected.

 Always wear eye protection when working on pumps.

 Make sure lifting handles are securely fastened each time before lifting. **DO NOT** operate pump without safety devices in place. Always replace safety devices that have been removed during service or repair. Secure the pump in its operating position so it can not tip over, fall or slide.

 **DO NOT** exceed manufacturers recommendation for maximum performance, as this could cause the motor to overheat.

DO NOT remove cord and strain relief. **DO NOT** connect conduit to pump.

WARNING! Cable should be protected at all times to avoid punctures, cut, bruises and abrasions. Inspect frequently. Never handle connected power cords with wet hands.

WARNING! To reduce risk of electrical shock, all wiring and junction connections should be made per the NEC or CEC and applicable state or province and local codes. Requirements may vary depending on usage and location.

WARNING! Submersible Pumps are not approved for use in swimming pools, recreational water installations decorative fountains or any installation where human contact with the pumped fluid is common.

WARNING! Products returned must be cleaned, sanitized, or decontaminated as necessary prior to shipment, to insure that employees will not be exposed to health hazards in handling said material. All Applicable Laws And Regulations Shall Apply.

 Bronze/brass and bronze/brass fitted pumps may contain lead levels higher than considered safe for potable water systems. Lead is known to cause cancer and birth defects or other reproductive harm. Various government agencies have determined that leaded copper alloys should not be used in potable water applications. For non-leaded copper alloy materials of construction, please contact factory.

 Crane Pumps & Systems, Inc. is not responsible for losses, injury, or death resulting from a failure to observe these safety precautions, misuse or abuse of pumps or equipment.

RECOMMENDED INSTALLATION

1. LOCATION: These units are self-contained and are recommended for use in a sump or basin. This pump shall NOT be installed in locations classified as hazardous in accordance with the National Electrical Code (NEC), ANSI/NFPA 70 or the Canadian Electrical Code (CEC). The sump or basin shall be vented in accordance with local plumbing codes. Provide proper sump diameter (approx. 14" minimum) and depth (approx. 18" minimum) to allow the pump to operate without restriction. Make sure sump is free of string, cloth, nails, gravel, etc. before installing pump. Never install the pump in a trench, ditch or hole with a dirt bottom where the suction may become plugged.

2. DISCHARGE: Discharge piping should be as short as possible. The installation of a check valve in the discharge piping is recommended for each pump being used. The check valve is used to prevent back flow into the sump. Excessive back flow can cause flooding and/or damage to the pump.

3. GENERAL: Never work in the sump with the pump on.

Plug the pump plug into a GFCI receptacle. One cycle of operation should be observed, so that any potential problems can be corrected.

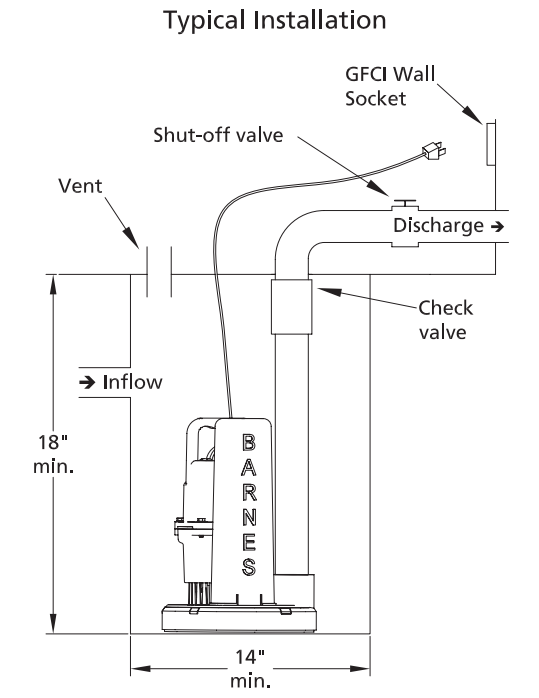

TROUBLE SHOOTING

CAUTION! Always disconnect the pump from the electrical power source before handling. If the system fails to operate properly, carefully read instructions and perform maintenance recommendations. If operating problems persist, the following chart may be of assistance in identifying and correcting them: MATCH "CAUSE" NUMBER WITH CORRELATING "CORRECTION" NUMBER.

NOTE: Not all problems and corrections will apply to each pump model.

PROBLEM	CAUSE	CORRECTION
Pump will not run	1. Poor electrical connection, blown fuse, tripped breaker or other interruption of power, improper power supply. 2. Switch will not activate pump or is defective. 3. Insufficient liquid level.	1. Check all electrical connections for security. Check for blown fuses, tripped circuit breakers or tripped GFCI outlets.
Pump will not turn off	2. Switch will not activate pump or is defective. 4. Excessive inflow or pump not properly sized for application.	2. Reposition pump or clean pump/basin as required to provide adequate clearance for float. 3. Make sure liquid level is at least equal to suggested turn-on point.
Pump hums but does not run	1. Incorrect voltage 8. Impeller jammed or loose on shaft, worn or damaged, inlet plugged.	4. Recheck all sizing calculations to determine proper pump size. 5. Check discharge line for restrictions, including ice if line passes through or into cold areas. 6. Remove and examine check valve for proper installation and freedom of operation.
Pump delivers insufficient capacity	1. Incorrect voltage. 4. Excessive inflow or pump not properly sized for application. 5. Discharge restricted. 6. Check valve stuck closed or installed backwards. 7. Shut-off valve closed. 8. Impeller jammed or loose on shaft, worn or damaged, inlet plugged.	7. Open valve. 8. Check impeller for freedom of operation, security and condition. Clean impeller and inlet of any obstruction. 9. Repair fixtures as required to eliminate leakage. 10. Check pump temperature limits & fluid temperature. 11. Replace portion of discharge pipe with flexible connector.
Pump cycles too frequently or runs periodically when fixtures are not in use	6. Check valve stuck closed or installed backwards. 9. Fixtures are leaking. 12. Ground water entering basin.	12. Check for leaks around basin inlet and outlets.
Pump shuts off and turns on independent of switch, (trips thermal overload protector). CAUTION! Pump may start unexpectedly. Disconnect power supply.	1. Incorrect voltage. 4. Excessive inflow or pump not properly sized for application. 8. Impeller jammed, loose on shaft, worn or damaged, inlet plugged. 10. Excessive water temperature.	
Pump operates noisily or vibrates excessively	5. Discharge restricted. 8. Impeller broken. 11. Piping attachments to building structure too rigid or too loose.	



Limited 24 Month Warranty

Crane Pumps & Systems warrants that products of our manufacture will be free of defects in material and workmanship under normal use and service for twenty-four (24) months after manufacture date, when installed and maintained in accordance with our instructions. This warranty gives you specific legal rights, and there may also be other rights which vary from state to state. In the event the product is covered by the Federal Consumer Product Warranties Law (1) the duration of any implied warranties associated with the product by virtue of said law is limited to the same duration as stated herein, (2) this warranty is a LIMITED WARRANTY, and (3) no claims of any nature whatsoever shall be made against us, until the ultimate consumer, his successor, or assigns, notifies us in writing of the defect, and delivers the product and/or defective part(s) freight prepaid to our factory or nearest authorized service station. Some states do not allow limitations on how long an implied warranty lasts, so the above limitation may not apply. **THE SOLE AND EXCLUSIVE REMEDY FOR BREACH OF ANY AND ALL WARRANTIES WITH RESPECT TO ANY PRODUCT SHALL BE TO REPLACE OR REPAIR AT OUR ELECTION, F.O.B. POINT OF MANUFACTURE OR AUTHORIZED REPAIR STATION, SUCH PRODUCTS AND/OR PARTS AS PROVEN DEFECTIVE. THERE SHALL BE NO FURTHER LIABILITY, WHETHER BASED ON WARRANTY, NEGLIGENCE OR OTHERWISE.** Unless expressly stated otherwise, guarantees in the nature of performance specifications furnished in addition to the foregoing material and workmanship warranties on a product manufactured by us, if any, are subject to laboratory tests corrected for field performance. Any additional guarantees, in the nature of performance specifications must be in writing and such writing must be signed by our authorized representative. Due to inaccuracies in field testing if a conflict arises between the results of field testing conducted by or for user, and laboratory tests corrected for field performance, the latter shall control. **RECOMMENDATIONS FOR SPECIAL APPLICATIONS OR THOSE RESULTING FROM SYSTEMS ANALYSES AND EVALUATIONS WE CONDUCT WILL BE BASED ON OUR BEST AVAILABLE EXPERIENCE AND PUBLISHED INDUSTRY INFORMATION. SUCH RECOMMENDATIONS DO NOT CONSTITUTE A WARRANTY OF SATISFACTORY PERFORMANCE AND NO SUCH WARRANTY IS GIVEN.**

This warranty shall not apply when damage is caused by (a) improper installation, (b) improper voltage (c) lightning (d) excessive sand or other abrasive material (e) scale or corrosion build-up due to excessive chemical content. Any modification of the original equipment will also void the warranty. We will not be responsible for loss, damage or labor cost due to interruption of service caused by defective parts. Neither will we accept charges incurred by others without our prior written approval.

This warranty is void if our inspection reveals the product was used in a manner inconsistent with normal industry practice and/or our specific recommendations. The purchaser is responsible for communication of all necessary information regarding the application and use of the product. **UNDER NO CIRCUMSTANCES WILL WE BE RESPONSIBLE FOR ANY OTHER DIRECT OR CONSEQUENTIAL DAMAGES, INCLUDING BUT NOT LIMITED TO TRAVEL EXPENSES, RENTED EQUIPMENT, OUTSIDE CONTRACTOR FEES, UNAUTHORIZED REPAIR SHOP EXPENSES, LOST PROFITS, LOST INCOME, LABOR CHARGES, DELAYS IN PRODUCTION, IDLE PRODUCTION, WHICH DAMAGES ARE CAUSED BY ANY DEFECTS IN MATERIAL AND/OR WORKMANSHIP AND/OR DAMAGE OR DELAYS IN SHIPMENT. THIS WARRANTY IS EXPRESSLY IN LIEU OF ANY OTHER EXPRESS OR IMPLIED WARRANTY, INCLUDING ANY WARRANTY OF MERCHANTABILITY OR FITNESS FOR A PARTICULAR PURPOSE.** No rights extended under this warranty shall be assigned to any other person, whether by operation of law or otherwise, without our prior written approval.