



# Combination Primary and Backup Sump Pump System



## Instruction Manual & Safety Warnings

### Table of Contents

<b>Important Safety Warnings and Instructions</b>		
Electrical precautions	2	
Battery preparation	2	
Battery precautions	2	
<b>Introduction</b>		
Items included in system	3	
Additional items needed	3	
System specifications	3	
<b>Installing the Pipe and Pump</b>	4	
<b>Battery Instructions</b>	5	
<b>Battery Maintenance</b>	5	
<b>System Connections</b>		
Mounting the backup control unit	5	
Connecting the backup pump	5	
Connecting the battery	5	
Connecting the charger	5	
Connecting the primary pump	5	
<b>Product Operation</b>	6	
		<b>Understanding the Warning Lights and Alarms</b>
		Silencing the alarm during an emergency
		Power alarm
		Backup pump alarm
		Replacing the backup pump
		Replacing the primary pump
		Battery alarm
		Cleaning battery terminals
		Replacing the battery
		<b>Testing the System</b>
		Testing the pump
		Testing the backup float switch
		Weep holes
		Testing the primary float switch
		<b>Maintenance Check List</b>
		<b>Parts &amp; Service Information</b>
		Technical support
		<b>Replacement Parts Diagram &amp; List</b>
		<b>Troubleshooting Guide</b>
		<b>Warranty</b>

Model CITE-33



**IMPORTANT:** Even if you have the Basement Watchdog sump pump system installed by someone else, you must read and follow the safety information contained in this manual. Failure to do so could result in property damage, serious injury, or death.

## Important Safety Warnings & Instructions

**SAVE THESE INSTRUCTIONS.** This manual contains important SAFETY WARNINGS and OPERATING INSTRUCTIONS for the Basement Watchdog combination sump pump system. You will need to refer to it before attempting any installation or maintenance. **ALWAYS** keep these instructions with the unit so that they will be easily accessible.

**FAILURE TO** read and follow these warnings and instructions could result in property damage, serious injury, or death. It is important to read this manual, even if you did not install the Basement Watchdog combination sump pump, since this manual contains safety information regarding the use and maintenance of this product. **DO NOT DISCARD THIS MANUAL.**

### ELECTRICAL PRECAUTIONS

#### ⚠ WARNING

This installation must be in accordance with the National Electric Code and all applicable local codes and ordinances.

#### ⚠ DANGER

**Risk of electrical shock and fire hazard. May result in death, serious injury, shock or burns. To help reduce these risks, observe the following precautions:**

- **DO NOT** walk on wet areas of the basement until all power has been turned off. If the main power supply is in a wet basement, call an electrician.
- **ALWAYS** disconnect the pump from the power source before servicing or making adjustments.
- **ALWAYS** unplug the control unit and disconnect the cables from the battery before attempting any maintenance or cleaning.
- **NEVER** handle the pump or motor with wet hands or when standing on a wet or damp surface while the pump is plugged into the power source.
- **MAKE SURE THERE IS A PROPERLY GROUNDED RECEPTACLE AVAILABLE.** This pump is wired with a 3-prong grounded plug. To reduce the risk of electric shock,

be certain that it is only connected to a properly grounded 3-prong receptacle. If you have a 2-prong receptacle, have a licensed electrician replace it with a 3-prong receptacle according to local codes and ordinances.

- **NEVER** bypass grounding wires or remove the ground prong from the plug.
- **DO NOT** use an extension cord. The electrical outlet should be within the length of the pump's power cord, and at least 4 feet above the floor level to minimize potential hazards from flood conditions.
- **DO NOT** use an attachment not recommended or sold by the manufacturer. It may result in a risk of fire or injury from an electrical shock.
- **DO** protect the electrical cord from sharp objects, hot surfaces, oil and chemicals. Avoid kinking the cord.
- **MAKE SURE** the supply circuit has a dedicated fuse or circuit breaker rated to handle the power requirements noted on the nameplate of the pump.

#### CAUTION

**To reduce the risk of hazards that can cause injury or property damage, observe the following precautions:**

- **DO NOT** use the power cord or strain relief to carry the pumps. Use the handle.
- **DO NOT** pull on the float switch cords.
- **DO NOT** pull on the cord to disconnect the system or the pump. Pull the plug.
- **DO NOT** expose the control units to water, rain or snow.
- **DO NOT** place the control units on the floor. The electrical outlet should be within the length of the pump's power cord, and at least 4 feet above the floor.
- **DO NOT** operate the pumps or control units if they have been damaged in any way.
- **DO NOT** use pumps in pits handling raw sewage, salt water, or hazardous liquids. This product is for ground water use only.
- **DO NOT** disassemble the pumps or control units. When service is required, contact Glentronics' technical support at 800-991-0466, option 3. Return the product to the manufacturer for any repairs at the following address:  
Glentronics, Inc., ATTN: Repairs  
645 Heathrow Drive, Lincolnshire, IL 60069

## BATTERY PREPARATION

### ⚠ WARNING / POISON

**Sulfuric acid can cause blindness or severe burns. Avoid contact with skin, eyes or clothing. In the event of accident, flush with water and call a physician immediately. KEEP OUT OF REACH OF CHILDREN.**

**To help reduce these risks, observe the following precautions:**

- Someone should be within range of your voice or close enough to come to your aid when you work near a lead-acid battery.
- Have plenty of fresh water and soap nearby in case battery acid contacts skin, clothing or eyes.
- Wear eye and clothing protection and avoid touching your eyes while working with battery acid or working near the battery.
- If battery acid contacts skin or clothing, wash immediately with soap and water. If acid enters eye, immediately flood eye with running cold water for at least 15 minutes and get medical attention.

**⚠ WARNING:** Battery posts and terminals contain lead, lead compounds or chemicals known to the State of California to cause cancer, birth defects or other reproductive harm. Wash hands after handling. See [www.p65warnings.ca.gov](http://www.p65warnings.ca.gov) for more information.

**⚠ WARNING:** Battery fluid can expose you to chemicals including strong inorganic acid mists containing sulfuric acid, which is known to the State of California to cause cancer. For more information go to [www.P65warnings.ca.gov](http://www.P65warnings.ca.gov).

### BATTERY PRECAUTIONS

#### ⚠ DANGER

**Explosive gases could cause serious injury or death. Cigarettes, flames or sparks could cause battery to explode in enclosed spaces. Charge in well-ventilated area. Always shield eyes and face from battery. Keep vent caps tight and level.**

**To help reduce these risks, observe the following precautions:**

- **NEVER** or allow a spark or flame in the vicinity of the battery.
- Use the Basement Watchdog control unit for charging a LEAD-ACID battery only. **DO NOT** use the control unit for charging

dry-cell batteries that are most commonly used with home appliances.

- Be sure the area around the battery is well-ventilated.
- When cleaning or adding water to the battery, first fan the top of the battery with a piece of cardboard or another nonmetallic material to blow away any hydrogen or oxygen gas that may have been emitted from the battery.
- **DO NOT** drop a metal tool onto the battery. It may spark or short-circuit the battery and cause an explosion.
- Remove personal metal items such as rings, bracelets, watches, etc. when working with a lead-acid battery. A short circuit through one of these items can melt it, causing a severe burn.
- **ALWAYS** remove the charger from the electrical outlet before connecting or disconnecting the battery cables. *Never allow the rings to touch each other if one is connected to the battery.*
- Check the polarity of the battery posts. The POSITIVE (+) battery post usually has a plus sign near it and the NEGATIVE (-) post has a minus sign nearby.
- When connecting the battery cables, first connect the large ring on the end of the BLACK wire to the POSITIVE (+) post of the battery, then the small ring on the end of the WHITE wire to the NEGATIVE (-) post of the battery.



- **ALWAYS** keep the cover secured on the battery box by slipping the tabs through the fittings on the front and back of the box. **DO NOT** place anything on top of the battery or battery box cover.

#### ⚠ DANGER

**Do not use system to pump flammable or explosive fluids such as gasoline, fuel oil, kerosene, etc.**



## Installing the Pipe and Pump

The Basement Watchdog combination system

is compact and will fit in a sump pit as small as 10" wide and 14" high (the size of a 5-gallon bucket). It measures 18½" from the bottom of the pump to the top of the wye connector where it will be attached to the discharge pipe.

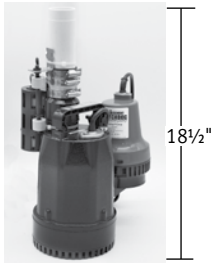

Use a pit that conforms to all local codes, and check the code to see if a gate valve or ball valve is required.

The path of the vertical discharge pipe to an exterior wall should have the shortest path with the fewest turns. More turns will reduce the pumping capacity. The discharge pipe must be positioned in a downward slope so any remaining water will drain away. Failure to do this will prevent water from exiting the pipe and damage the pump if the line freezes. (see Diagram A)

The system should be placed on a flat surface free from dirt and debris. If the bottom of the

sump pit is not clean, remove as much of the debris as possible. You should place a pump stand or bricks on the floor of the sump pit to raise the pump above the debris.

If you are replacing an old sump pump, **unplug the pump from the outlet.**

1. Remove check valve or rubber union. If the existing system does not have a check valve or union, cut the pipe above the sump as shown in step 3 below. **Discard the check valve. Since the Basement Watchdog system has built-in check valves, the old one is not necessary.**
2. Remove the old pump from the pit, and unscrew the pipe and pipe adapter from the pump.
3. The existing discharge should be cut or added on to, so that the distance from the bottom of the sump pit



(or from the top of the bricks/stand in the sump pit) to the end of the existing discharge is 19".

4. (a) Connect this piece to the discharge pipe by cementing the two pieces together with a 1½" PVC pipe connector. (Follow the instructions on the PVC pipe cleaner and cement.) **or,** (b) connect the two pieces of pipe together with a rubber union.
5. Remove the assembled pump system from the shipping carton by lifting the strap at the top of the unit and using your other hand to support the unit. Stand the unit on the ground near the sump pit. Visually inspect your pump. Products may be damaged during shipping. If the product has been damaged, contact your place of purchase or Glentronics before installation.
6. Cut the lifting strap off of the pump and the other straps.
7. Remove the attached cords and controllers from the carton and place them next to the pump system. **BE SURE THE CORDS AND CONTROLLERS DO NOT FALL INTO THE SUMP PIT DURING THE INSTALLATION.**

8. Loosen the hose clamps on the enclosed rubber union, and slide the union up on the discharge pipe until it is even with the bottom of the pipe.
9. Inspect the two float switches. They should both be vertical and positioned so that they move smoothly without hitting the pump or the wall of the sump pit.
10. Inspect all of the screws on the hose clamps of the no-hub couplings (primary and backup pumps). They should be tight.
11. Lift the combination system by the handle on the primary pump and lower it into the sump pit. Make sure it is level.
12. Position the top of the pump system pipe so it is directly below the discharge pipe. Slide the rubber union down until half of the rubber union is covering the pump pipe, and the other half is covering the bottom of the discharge pipe. Tighten the hose clamp screws securely.
13. A pit cover is recommended for all installations as a safety measure and to prevent debris from falling into the pit. Place the cover on top of the pit, making sure not to pinch or crimp the pump wires with the cover. The pit cover usually has

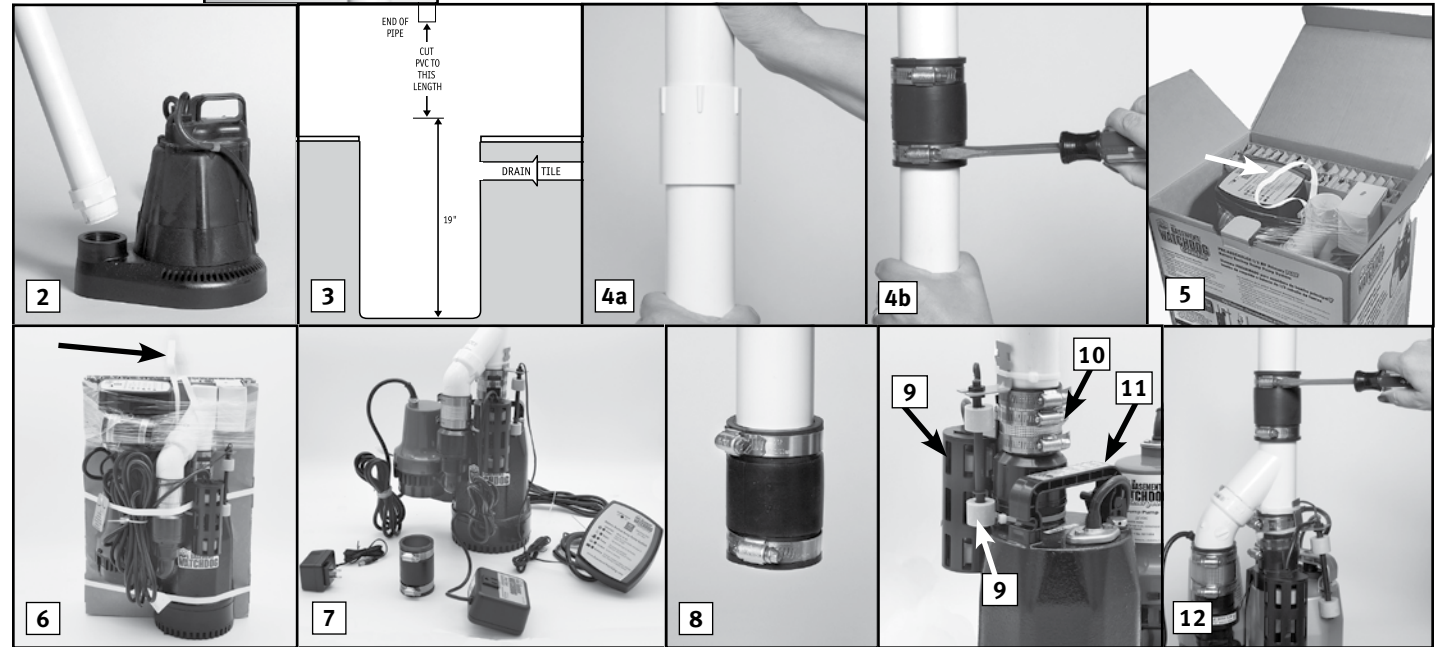
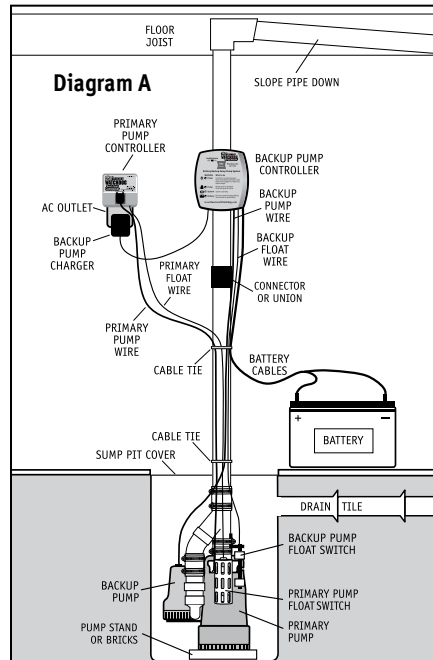

an existing hole that will allow the cords to be passed through it, or you can drill a hole in the cover.

## Battery Instructions

The Basement Watchdog maintenance free battery (BW-27AGM) has been designed to run this system for 48 hours, based on a 10% duty cycle. However, most of the time the pump will turn on and off, and the battery will run the pump intermittently for days. In addition, the unique materials in the Basement Watchdog AGM battery enable it to last longer in standby service. Only lead acid batteries should be used to power this system.

*NOTE: The battery will not run the primary pump.*

*NOTE: Runtimes will vary based on inflow of water.*



### CAUTION

- The use of automotive batteries is NOT recommended. Automotive batteries are not designed for this application. They will only run the pump for a short time and will have a shorter life than a standby battery.
- The Basement Watchdog AGM standby batteries are specifically designed to work with your battery backup sump pump system. The internal structure of some batteries may not be compatible with this system. Glentronics can not guarantee the compatibility of other brands of batteries. For optimal performance the use of a Basement Watchdog standby battery is **HIGHLY** recommended.

### ⚠ DANGER/POISON

Batteries contain sulfuric acid. Wear eye and clothing protection. If battery acid contacts

skin or clothing, wash immediately with soap and water. If acid enters eyes, flush with water for 10 minutes and get medical attention. Review the safety instructions on page 2.

## System Connections

### ⚠ DANGER

**Risk of electrical shock or battery explosion, which can cause serious injury or death. Unplug the main AC pump to avoid electrical shock. Wear eye protection. Work in a well-ventilated area. Do not smoke or allow a spark or flame in the vicinity of the battery. Avoid dropping metal tools on the battery. If battery acid contacts eyes, flush with water for 15 minutes and get prompt medical attention. Review the safety instructions on page 2.**

### MOUNTING THE CONTROLLER

When you position the backup system control unit on the discharge pipe, be sure the charger cord will reach the AC power outlet and the pump cable and the float switch will reach the bottom of the sump. Position the unit in a well-ventilated area. Do not place anything on top of the battery. (Diagram C)

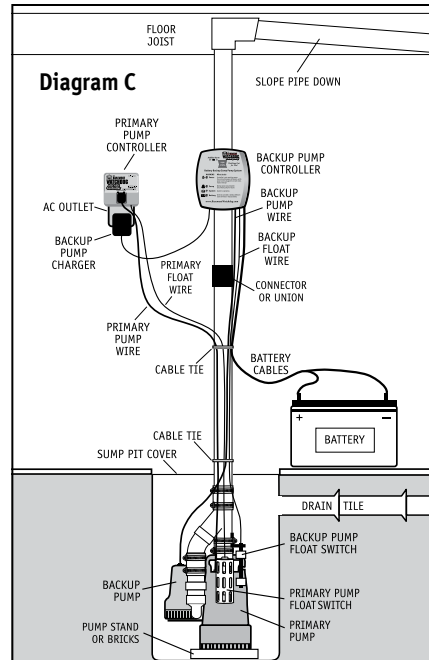

1. **Mounting the backup control unit:** (a) Thread one plastic cable tie through the two mounting brackets on the back of the control unit. (b) Secure the controller to the discharge pipe by wrapping the tie around the pipe and pulling it tight.

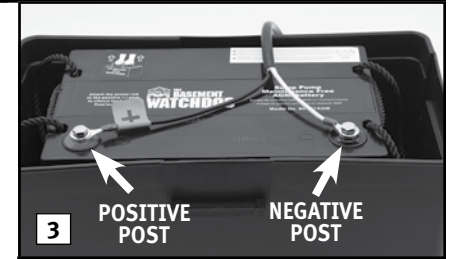

2. **Connecting the backup pump:** Remove the security tag from the pump and plug the pump wire into the pump connector on the back of the control unit.

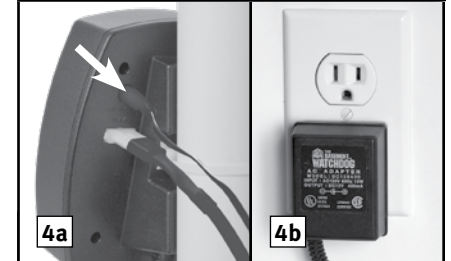

3. **Connecting the battery:** Remove the bolts from the battery. Remove the security tag from the battery cables. Attach the battery cables to the battery... the BLACK wire to the POSITIVE (+) post and then the WHITE wire to the NEGATIVE (-) post. Replace the bolts and tighten. *Note: Connecting the cables to the wrong posts will damage the controller.*

4. **Connecting the charger:** Immediately plug the charger into the charger jack on the back of the control unit, then into an AC outlet on the wall. (A surge protector that protects all three pins on the power plug is recommended - backup system only.)



5. If the pump alarm is sounding, press the Reset button to silence the alarm.
6. Replace the battery box cover.



7. **Connecting the primary pump:** Plug the blue piggyback controller into a properly grounded 3-prong outlet. Then plug the primary pump into the receptacle on the controller.
8. For a neater installation, secure the cables from the controllers to the discharge pipe in several places with the additional cable ties. Make sure the wires are not touching or overlapping each other.
9. After the initial installation, check each

pump for proper operation. To check the primary pump, fill the sump pit with water and observe the pump through several full cycles. The primary pump should run for 10 seconds after the lower float drops. To check the operation of

the backup pump, manually raise the backup float and let it go. The backup pump will run for approximately 25 seconds. After the backup pump has stopped, push the red Reset button.

- A pit cover is recommended for all installations as a safety measure, and to prevent debris from falling into the pit. Place the cover on top of the pit, making sure not to pinch or crimp the pump wires with the cover. The pit cover usually has an existing hole that will allow the cords to be passed through it, or you can drill a hole in the cover.

## Product Operation

The dual float switch on the primary pump contains two large floating rings enclosed within a protective cage. Water will lift the bottom float about 1/4", which will activate the pump. If for any reason the lower float does not activate the pump, the water will rise to the second float, and it will activate the pump. As the pump evacuates the water from the pit, the floats will drop. The pump will run for an additional 10 seconds after the activating float drops to fully empty the pit. The blue Dual Float Controller sends power to the primary pump when it sees that the dual float is calling for action.

During a power outage, or when more water is entering the sump than the primary pump can handle, the backup pump will automatically begin pumping. It also has a dual float switch, so if one float fails to activate the pump, the second float will activate the pump as soon as the water reaches that level. As the water recedes below the float switch, a timer in the control unit will run the pump an additional 25 seconds to evacuate the pit.

While the pumps are active, water will come out of the 3/16" hole that is located on the top



of the main pump, and out of the 3/16" hole in the check valve of the backup pump. This is normal. The holes are needed to prevent an air lock within the system. **DO NOT** obstruct the holes or an air lock may prevent the system from moving water.

Batteries and sump pumps need maintenance. The control unit on the backup system monitors the battery and power conditions, and sounds an alarm when maintenance is required. Following is an explanation of the warnings and alarms.

WARNING		What to do
①	Power	Controller is not receiving power. Check circuit breaker, GFCI outlet, power cord is plugged in or replace charger
②	Pump	Backup pump was activated. Check main pump for failure
③	System	System is operating
④	Battery	Terminals corroded or battery low. Clean terminals or replace battery

## Understanding the Warnings & Alarms

The Basement Watchdog backup control unit features a series of warning lights that pinpoint potential problems. In addition, an alarm sounds to alert you to the problem. In some cases the lights and alarm will go off automatically when the problem has been solved. In others, the Reset button must be pushed to silence the alarm. Refer to the table below for a quick review of the features and their corresponding alarm status.

### SILENCING THE ALARM DURING AN EMERGENCY

The Basement Watchdog backup sump pump system is equipped with a switch that will silence the audible alarm during an extended emergency. The POWER and PUMP alarms can be silenced during a power outage or during heavy rains when the pump is activated repeatedly.

To silence the POWER and PUMP alarms, slide the audible alarm switch to OFF. The POWER and/or the PUMP light will remain on,

but the audible alarm will not sound.

**When the emergency has ended, slide the switch to the ON position to resume the full monitoring capability, or you will not be warned the next time an emergency occurs.**

The BATTERY alarm cannot be silenced. It requires immediate attention.

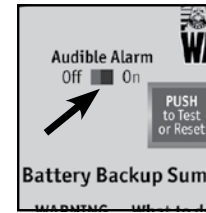

Warning	Alarm can be silenced before problem is corrected	Alarm shuts off automatically when the problem is corrected
POWER	Yes	Yes
PUMP	Yes	No, push RESET button
SYSTEM	No Alarm	No Alarm
BATTERY	No	Yes

### ① Power

There are several causes for power failure. The most common is a power outage by your electric company. During this emergency, the Basement Watchdog system will automatically switch to battery power and protect your basement from flooding. You can silence the POWER alarm by sliding the audible alarm switch to OFF. The alarm will be silenced, but the light will stay on. The system will continue to operate while the power alarm is silenced. **Be sure to slide the switch to the ON position when power is restored to resume full monitoring capability.**

- If the power is on in the rest of the house, check the home circuit breaker

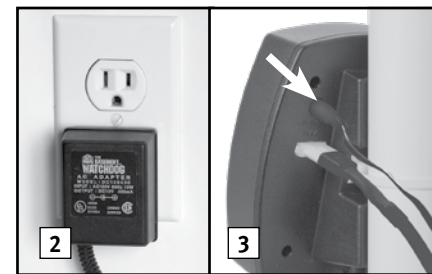

or fuse box, check the GFCI, and check the outlet for failure, and correct the problem.

- Check the charger. Make sure it is securely plugged into the wall outlet. Make sure the power outlet is working.
- Check the charger plug that fits into the rear panel of the control unit. Make sure it is securely plugged into the control unit.

The control unit must receive 115 volts AC +/- 5% from the AC outlet. Any voltage lower than 110 volts will activate the POWER alarm. Lower voltages can be caused by utility brown outs or a heavy power draw from other appliances on the same circuit.

If all the connections are secure and the wall outlet is operating, but the POWER warning light is still on, replace the charger unit with Basement Watchdog part number 1015003. Contact Glentronics, Inc. at 800-991-0466, option 3.

### ② Pump

When the water rises in the sump pit and lifts the float switch, the pump will begin pumping, and the PUMP light and alarm will turn on. Try to determine what caused the system to activate.

- Check the main pump for failure. It may not be working, the float switch may be stuck, or the pump may be too small to handle the inflow of water.
- Make sure the check valves are working and installed correctly. (See page 11 for check valve locations).
- Make sure the discharge pipe is not clogged or frozen.
- If the power was out, and the backup pump was activated, push the Reset button to silence the alarm.

During a power outage or times when the pump is activated repeatedly, you can temporarily silence the alarm by sliding the Audible Alarm switch to OFF. **When**

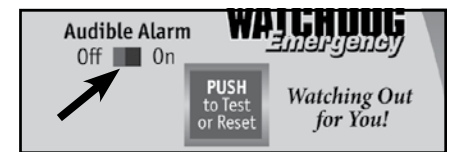

the primary pump has resumed normal operation and the backup pump is no longer activating repeatedly, slide the switch to the ON position to resume the full monitoring capability. The alarm and pump light will still be on. Push the Reset button to silence the alarm.

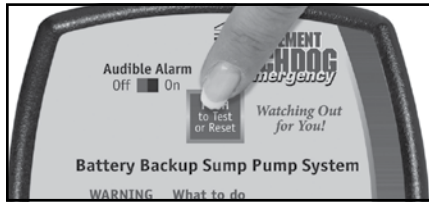

## REPLACING THE BACKUP PUMP

Before you begin this process, purchase a new backup pump. We recommend you change the check valves at this time. The backup pump uses a 1¼" check valve, the primary pump uses a 1½" check valve. (See parts list on page 11.)



### **⚠ DANGER**

Risk of electrical shock or battery explosion, which can cause serious injury or death. Wear eye protection. Work in a well-ventilated area. Do not smoke or allow a spark or flame in the vicinity of the battery. Avoid dropping metal tools on the battery. Review the safety instructions on page 2.

**YOU WILL BE DISCONNECTING ALL THE WIRES. BE SURE THEY DO NOT FALL INTO THE SUMP PIT. SEE DIAGRAM ON PAGE 11 FOR PARTS DESCRIPTION.**

1. Unplug the primary pump from the blue controller.
2. Remove the charger plug from the back of the backup controller.
3. Unplug the backup pump from the back of the backup controller.
4. Remove the cover of the battery box. Fan the area around the top of the battery with a piece of cardboard (or another nonmetallic material) to remove any

hydrogen or oxygen gas that may have been emitted from the battery.

5. Remove the battery wires from the battery terminals. **Be sure they do not touch each other while one is connected to the battery.**
6. Slowly loosen the rubber union on the top of the combination pump assembly to separate the pipes. The water trapped in the pipe will pour out into the sump as the rubber union is loosened.
7. Separate the pump assembly from the rubber union and lift it out of the sump by the handle on the primary pump.
8. Turn the assembly up side down over the sump pit to allow the remaining water in the system to drain.
9. Loosen all of the screws on the no-hub connectors for the backup pump, primary

pump and primary float switch. Remove the wye pipe.

10. Slide the backup pump assembly out of the seat in the handle of the primary pump.
11. Unscrew the screw on the bottom of the pump bracket with a Phillips head screwdriver, and lift the pump off of the bracket.
12. If you do not have a new check valve, unscrew the check valve on the elbow of the backup pump. Now reverse the process.
13. Screw the old/new check valve and no-hub on to the new pump. (We recommend replacing the check valve with a new one.)
14. Place the pump on the bracket and screw it onto the bracket.

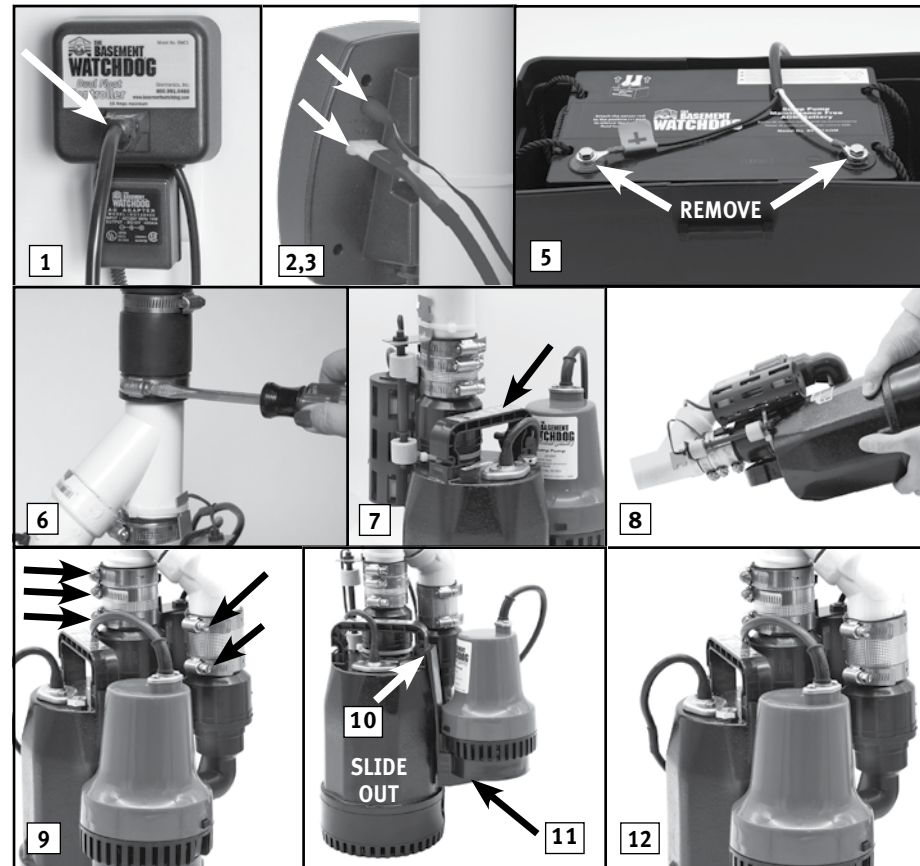

15. Slide the backup pump assembly into the seat in the handle of the primary pump.
16. Replace the wye pipe and tighten the hose clamps on both no-hub connectors and the primary pump float switch.
17. Lower the pump system back into the sump pit using the primary pump handle.
18. Connect the top of the system to the rubber union and tighten the hose clamp.
19. Connect the battery cables to the battery terminals, BLACK to the POSITIVE (+) post and WHITE to the NEGATIVE (-) post.
20. Replace the cover of the battery box.
21. Plug the backup pump into the back of the backup controller.
22. Plug the charger into the back of the backup controller.
23. Plug the primary pump into the blue controller.
24. Test the system; run it through several full cycles.

## REPLACING THE PRIMARY PUMP

Before you begin this process you will need a new AC pump. We recommend changing the check valves at this time. The backup pump uses a 1¼" check valve, the primary pump uses a 1½" check valve. (See parts list on page 11.)



### **⚠ DANGER**

Risk of electrical shock or battery explosion, which can cause serious injury or death. Wear eye protection. Work in a well-ventilated area. Do not smoke or allow a spark or flame in the vicinity of the battery. Avoid dropping metal tools on the battery. Review the safety instructions on page 2.

**YOU WILL BE DISCONNECTING ALL THE WIRES. BE SURE THEY DO NOT FALL INTO THE SUMP PIT. SEE DIAGRAM ON PAGE 11 FOR PARTS DESCRIPTION.**

1. Unplug the primary pump from the blue controller.

2. Remove the charger plug from the back of the backup controller.
3. Unplug the backup pump from the back of the backup controller.
4. Remove the cover of the battery box. Fan the area around the top of the battery with a piece of cardboard (or another nonmetallic material) to remove any hydrogen or oxygen gas that may have been emitted from the battery.
5. Remove the battery wires from the battery terminals. **Be sure they do not touch each other while one is connected to the battery.**
6. Slowly loosen the rubber union on the top of the combination pump assembly to separate the pipes. The water trapped in the pipe will pour out into the sump pit

as the rubber union is loosened.

7. Separate the pump assembly from the rubber union and lift it out of the sump by the handle on the primary pump.
8. Turn the assembly up side down over the sump pit to allow the remaining water in the system to drain.
9. Cut the cable ties on the backup float switch and remove it.
10. Loosen the screws of the no-hub connectors on the primary pump, the primary float and the backup pump.
11. Remove the wye pipe.
12. Carefully slide the backup pump and bracket out of the handle of the primary pump.
13. Unscrew the primary pump check valve.

Now reverse the process.

14. Screw in the check valve on the top of the new primary pump. (You can use the existing check valve, or preferably replace it with a new one.)
15. Carefully slide the backup pump and bracket into the handle of the new primary pump.
16. Connect the wye connector to the top of the check valve with the no-hub connector.
17. Connect the backup pump to the other side of the wye connector with the other no-hub connector.
18. Replace the caged dual float switch. Tighten all hose clamps on the primary, backup, and float switch.
19. Replace the backup pump float switch using 2 new cable ties. Make sure the float moves easily, and will not get hung up on the pump.
20. Lower the pump back into the pit by the handle of the primary pump.
21. Connect the top of the system to the rubber union and tighten the hose clamp.
22. Connect the battery cables to the battery terminals, BLACK to the POSITIVE (+) post and WHITE to the NEGATIVE (-) post.
23. Replace the cover of the battery box.
24. Plug the backup pump into the back of the backup controller.
25. Plug the charger into the back of the backup controller.
26. Plug the primary pump into the blue controller.
27. Test the system through several full cycles.

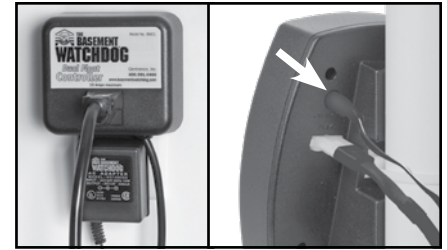

- Check the charger plug that fits into the rear panel of the control unit. Make sure it is securely plugged into the control unit.
- If all connections are secure and the wall outlet is operating, but the SYSTEM light is not flashing, call Glentronics parts department at 800-991-0466, option 3.

#### ④ Battery

This light and alarm will go on when the control unit senses corrosion on the terminals, the battery is aging, or the battery has approximately 1/2 hour of continuous pumping energy left. This alarm cannot be silenced. It indicates that your battery is discharged or defective and immediate action needs to be taken to replace the battery or clean the terminals. This alarm will sound when:

- Corrosion on battery terminals and/or cable rings is preventing the battery from charging properly
- The battery is getting old and should be replaced
- The pump has been running for many hours and the battery is discharged

Check the battery cables and the battery terminals for corrosion. Clean and tighten them as needed. The procedure is described on page 9.

If the battery alarm goes on while the pump is running and the power is out, you will have 1/2 hour of pumping time to replace the battery. (In most cases, the pump does not run continuously, and therefore, you actually have a longer time to replace it.) You will not be able to silence the alarm. Left unattended, the basement will flood. In a severe emergency, if a replacement battery is not available, you could temporarily use

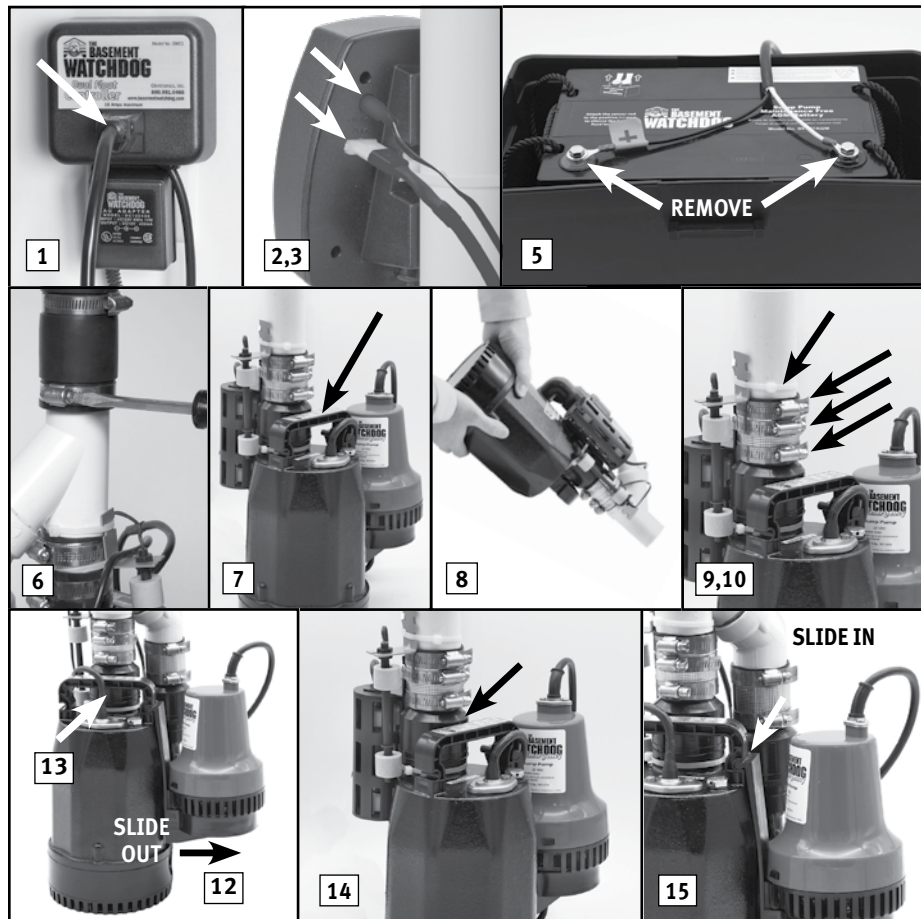

#### ③ System

This green light should always be flashing. It indicates that the system is operating, and the battery is connected. If this light is off:

- Check the charger. Make sure it is securely plugged into the wall outlet.

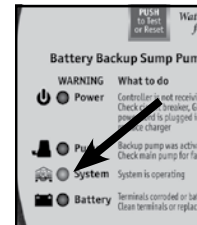



your car battery.

Once the AC power is restored, the battery will recharge automatically, unless it is old or damaged. The alarm will go off when the AC power is restored and the pumping energy reaches 1/2 hour or more.

In the event that your Basement Watchdog backup sump pump has pumped for an extended period of time, the battery may be very depleted. In this condition, when the AC power is returned to the unit, a battery alarm will continue to sound. The battery may need a longer period to recharge or require an automotive or marine battery charger.

For a faster recharge, an automotive or marine battery charger can be used to recharge the battery. Follow the manufacturer's instruction and safety information included with the charger. Make sure the backup control unit is disconnected from the battery.

If the battery is relatively new and the battery alarm is activated, before you replace the battery, call the Glentronics service department at 800-991-0466, option 3.

## TO CLEAN THE BATTERY TERMINALS AND CABLES

### ⚠ DANGER

**Risk of electrical shock or battery explosion, which can cause serious injury or death. Wear eye protection. Work in a well-ventilated area. Do not smoke or allow a spark or flame in the vicinity of the battery. Avoid dropping metal tools on the battery. If battery acid contacts eyes, flush with water for 15 minutes and get prompt medical attention. Review the safety instructions on page 2.**

### REFER TO THE PHOTOS AT RIGHT

1. Unplug the charger and blue AC controller from the wall outlet.
2. Remove the cover of the battery box.
3. Fan the area around the top of the battery with a piece of cardboard (or another nonmetallic material) to remove any hydrogen or oxygen gas that may have been emitted from the battery.
4. Remove the battery cables.
5. Clean the battery posts with a battery terminal cleaner or a wire brush.

6. Clean any corrosion off of the ring connectors on the ends of the battery wires. **DO NOT** apply corrosion-resisting sprays or pads to the terminal rings or posts after you have cleaned them, as this could prevent the system from charging properly.
7. Replace the battery cables, BLACK to the POSITIVE (+) post and WHITE to the NEGATIVE (-) post. Replace and tighten the bolts and replace the cover of the battery box.
8. Plug the charger and the blue AC pump controller back into the wall outlet.
9. You may have to press the Reset button to silence the PUMP alarm.

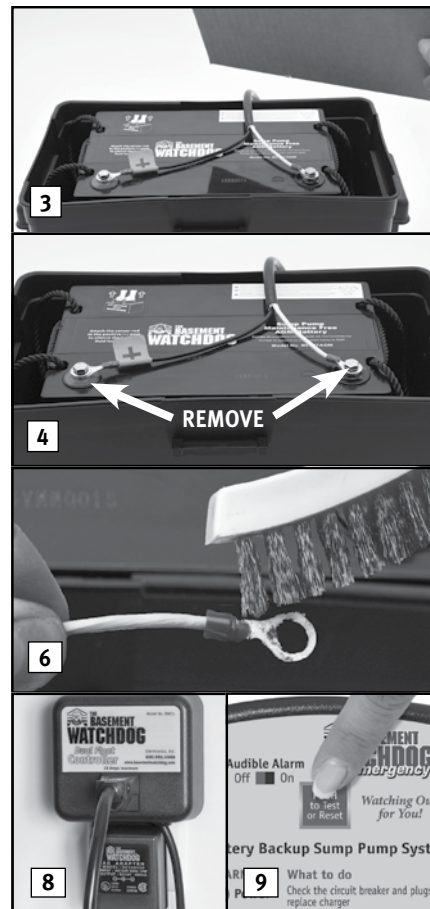

## REPLACING THE BATTERY

### ⚠ DANGER

**Risk of electrical shock or battery explosion, which can cause serious injury or death. Wear eye protection. Work in a well-ventilated area. Do not smoke or allow a spark or flame in the vicinity of the battery. Avoid dropping metal tools on the battery. If battery acid contacts eyes, flush with water for 15 minutes and get prompt medical attention. Review the safety instructions on page 2.**

### REFER TO THE PHOTOS AT RIGHT

1. Unplug the charger and blue AC controller from the wall outlet.
2. Remove the cover of the battery box. Fan the area around the top of the battery with a piece of cardboard (or another nonmetallic material) to remove any hydrogen or oxygen gas that may have been emitted from the battery.
3. Unscrew the bolts and remove the battery cables.
4. Remove the old battery and replace with new.
5. Clean any corrosion off of the wire ring connectors on the end of the battery cables. Use a wire brush or sandpaper. **DO NOT** apply corrosion-resisting sprays or pads to the terminal rings or posts after you have cleaned them, as this could prevent the battery from charging properly.
6. Replace the battery cables, BLACK to the POSITIVE (+) post and WHITE to the NEGATIVE (-) post.
7. Plug the charger and the blue AC controller into the wall outlet. Replace the cover of the battery box.
8. You may have to press the Reset button to silence the PUMP alarm.

## TEST-RESET BUTTON

The TEST button may be used to check the backup pump and system. Push the TEST button, which will activate the pump for as long as you hold the button.

## TESTING THE BACKUP FLOAT SWITCH

**It is important to manually test the float switch periodically or after any maintenance.**

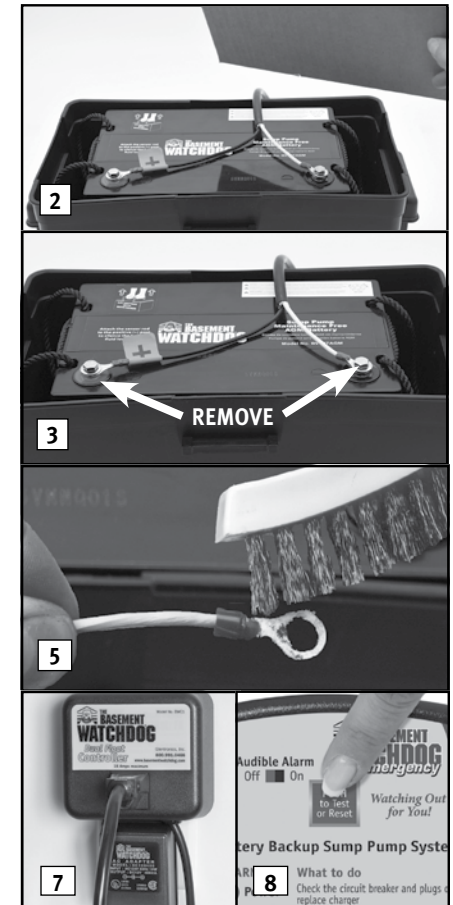

Lift the float up and let go. This will activate the pump. The control unit will run the pump for approximately 25 seconds so it can empty all the water in the sump pit. If there is no water in the pit,

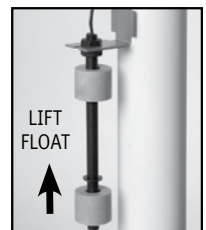

the pump can run dry for this amount of time. The alarm will sound and the PUMP light will go on. After the pump has stopped, push the Reset button to silence the alarm. If the Reset button is pressed before the pump has stopped, the alarm will go off temporarily. Wait for the pump to stop pumping, and then push the Reset button to completely silence the alarm.

## WATER SPRAYING FROM PUMP

While the pumps are active, water will come out of the  $\frac{3}{16}$ " hole located on the top of the main pump and the  $\frac{3}{16}$ " hole located in the check valve of the backup pump. This is normal. The holes are needed to prevent an air lock within the system. DO NOT obstruct the holes or an air lock may prevent the system from activating.



## TESTING THE PRIMARY PUMP FLOAT SWITCH

***It is important to manually test the float switch periodically or after any maintenance.***

Lift the float within the cage with a pencil or other nonmetallic item and let it drop. The pump will run for an additional 10 seconds after the float returns to the original position. It will not damage the pump to run it for this short time if the sump pit is dry. However, **DO NOT** hold the float up for an extended time without water in the sump.

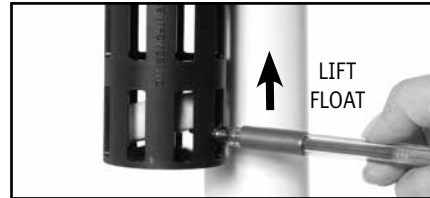

## MAINTENANCE CHECKLIST

Maintenance should be performed 1-2 times per year.

1. Lift the float switches on both pumps as described at left.
2. Remove all debris from the bottom of the pit and the pump strainer.
3. Remove all debris floating in the water.
4. Remove all debris from the float switch cage.
5. Fill the pit with water. Make sure the pumps turn on at the intended levels.
6. While the pumps are running, make sure the pump is evacuating water at a good pace and water is coming out of the  $\frac{3}{16}$ " air vent on the top of the primary pump or the  $\frac{3}{16}$ " air bleed hole in the check valve of the backup pump.
7. Check and clean battery terminals.

# Replacement Parts List

Description	Part No.
1/3 HP AC sump pump	SIT-33NS
Caged dual float switch with piggyback controller	BWC2
Emergency backup pump	1011014
Emergency control unit	BWE-CONT
Wye PVC pipe fitting with 45° elbow	1120017
Support bracket for backup pump	1121018
Battery cap with hole for the fluid sensor	1125000
Charger for backup pump	1015003
Backup dual float switch	FLOAT-DL-MC
Backup pump locking screw (#12 x 1/2" pan head)*	1100018
1 1/4" check valve with weep hole for backup pump*	1141006
1 1/2" check valve for primary pump*	1141003
No-hub stainless-steel connectors*	1142000
1 1/2" rubber union*	1142001
1 1/2" hose clamp*	1122002
Cable tie*	1122000

\*Stock items available in plumbing department

Call 800-991-0466, option 3, to order parts.

## PARTS & SERVICE INFORMATION

You can receive technical support, parts or service information by calling Glentronics, Inc. at 800-991-0466, option 3, or by visiting the website at [basementwatchdog.com](http://basementwatchdog.com). Send your unit to the following address for repairs:

Glentronics, Inc., ATTN: Repairs Dept.  
645 Heathrow Drive, Lincolnshire, IL 60069

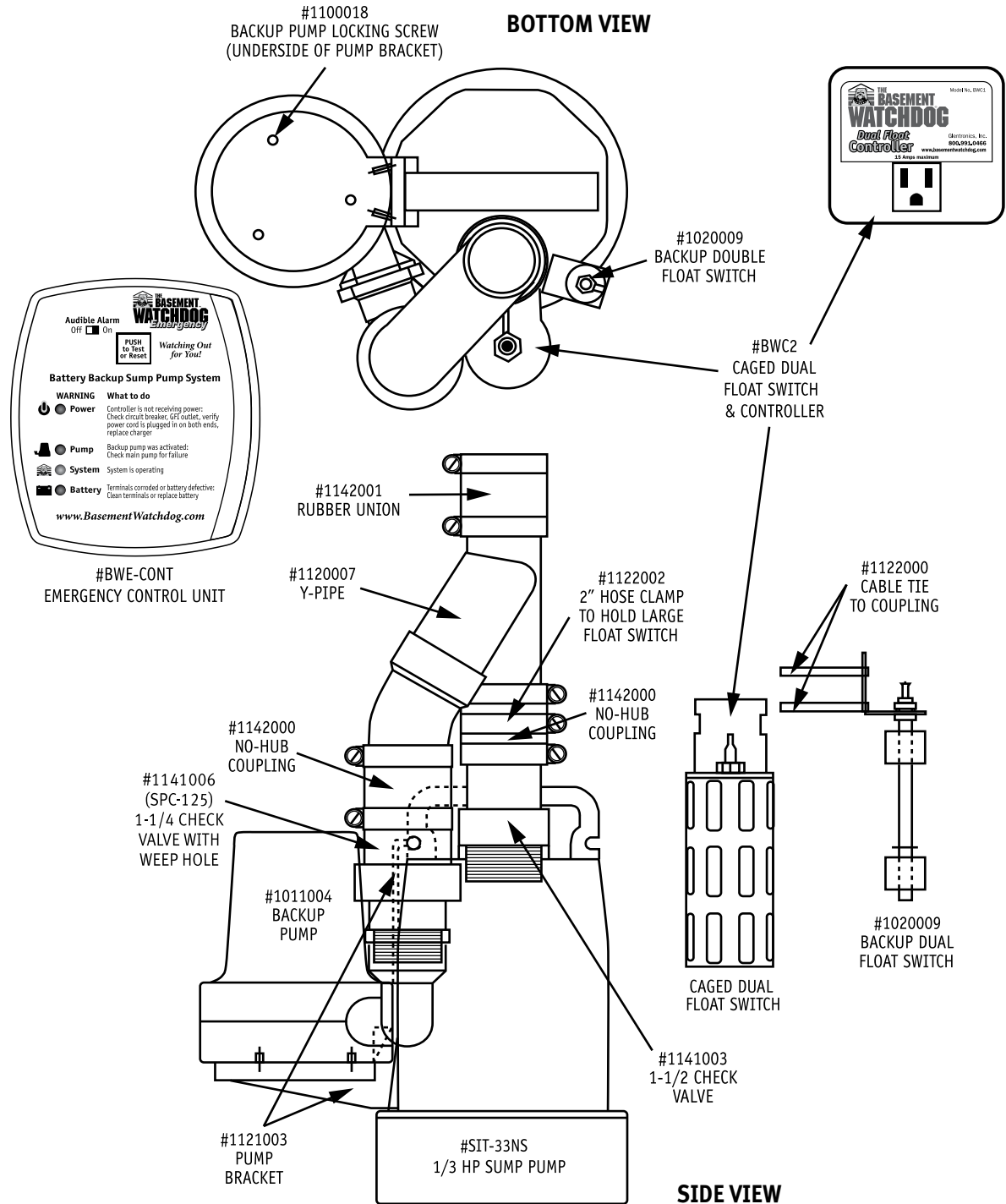

# Primary Pump Troubleshooting Guide

**⚠ DANGER**

Read safety warnings & instructions before attempting any repairs or maintenance.

Potential Cause	THE PUMP WILL NOT START OR RUN	Solutions
Pump is not plugged in .....	Plug pump in properly (see instructions)	
No AC power .....	Check circuit breaker or fuse	
Poor power source .....	Check circuit line wires, cable and outlet	
Locked impeller .....	Remove strainer and clear obstruction	
Defective float switch .....	Replace float switch with new float switch	
Defective pump .....	Replace pump with new pump	

Potential Cause	THERMAL PROTECTOR TRIPPING OR NOT FUNCTIONING	Solutions
Locked impeller .....	Remove strainer and clear obstruction	
Incorrect power supply .....	Check power supply source and voltage	
Pump running continuously with no water present...	Check float switch	

Potential Cause	PUMP STARTS AND STOPS TOO FREQUENTLY	Solutions
Float switches mounted too low .....	Raise both float switches	
Water backflowing from pipe .....	Replace check valve	
Malfunctioning float switch .....	Replace float switch with new float switch	

Potential Cause	PUMP WILL NOT SHUT OFF	Solutions
Clogged or frozen discharge .....	Clear blockage or thaw frozen line	
Blocked intake strainer .....	Clear debris from intake strainer	
One or both of the floats is obstructed and cannot drop ..	Clear debris from inside the float cage (Loosen nut on top of float, then remove c-clip on bottom of float. Remove debris. Tighten nut on top of float, then replace c-clip on bottom of float.) When reassembling the float, the magnetic strip on the inside of the float should be facing down.	
Defective float switch .....	Replace float switch with new float switch	
Check valve is stuck .....	Replace check valve	

Potential Cause	INSUFFICIENT OR NO WATER VOLUME	Solutions
Check valve on secondary pump will not close and water recirculates within the system .....	Replace the check valve on the secondary pump	
Partially blocked impeller .....	Remove strainer and clear obstruction	
Clogged or frozen discharge pipe .....	Clear blockage or thaw frozen line	
Broken or leaking pipe .....	Repair pipe	
Low power voltage .....	Check power voltage, wires and cable condition	
Check valve is stuck .....	Replace check valve	
There is an air lock within the system .....	Make sure the air relief valve located on the top of the primary pump is clear of debris	

Potential Cause	ABNORMAL SOUND OR VIBRATION	Solutions
Check valve is broken .....	Replace the check valve	
Blocked intake screen .....	Clear debris from intake screen	
Defective pump .....	Replace pump	

If the above solutions do not resolve the problem, follow the instructions within this manual to disconnect the system from the outlet and battery terminals, then reconnect the system and push the reset button. If the problem continues, contact customer service.

# Backup Pump Troubleshooting Guide

**⚠ DANGER**

Read safety warnings & instructions before attempting any repairs or maintenance.

Potential Cause	BATTERY PROBLEM	Solutions
Terminals are corroded .....	Clean terminals and cables	
Cables are loose .....	Tighten wing nuts/bolts	
Battery is discharged below 25% .....	Replace battery if power is out. There is only ½ hour of continuous pumping power left. Battery will recharge when power is restored.	
Battery is old or damaged.....	Replace battery	

Potential Cause	POWER FAILURE	Solutions
Power outage.....	None. Silence the alarm for 24 hours	
A circuit breaker, fuse, or outlet has failed .....	Rest the circuit breaker, replace the fuse, or repair the outlet	
The charger is unplugged from either end.....	Make sure the power cord is plugged in securely at both ends	
The control unit is receiving less than 110 volts from the outlet.....	None, if the utility company has instigated brownouts. Otherwise, reduce the number of other appliances on the circuit	

Potential Cause	PUMP WILL NOT SHUT OFF	Solutions
Backup pump is clogged .....	Remove strainer from pump and clean out any debris	
Defective float switch .....	Replace float switch with new float switch	
Check valve is stuck .....	Replace check valve	
Backup pump is broken .....	Replace the pump	
A slight chance of false activation exists if the float switch is wrapped around the AC power cord .....	Move the float switch cord away from the AC power cord	

Potential Cause	INSUFFICIENT OR NO WATER VOLUME	Solutions
Backup pump is unplugged .....	Make sure the pump is securely plugged into the controller	
The check valve is stuck and the water cannot pass through it .....	Replace check valve	
The discharge pipe is clogged or frozen.....	Thaw, clean out the blockage, or replace the discharge pipe	
There is an air lock within the system .....	Make sure the 3/16" weep hole built into the check valve is not clogged or covered	

Potential Cause	BACKUP PUMP ACTIVATED	Solutions
The main AC pump failed because of a power outage . .	None. The backup pump was activated when needed	
The float switch on the main AC pump is stuck or defective .....	Free the float switch on the main pump or replace it	
The main AC pump is broken.....	Replace the main AC pump	
The main AC pump could not keep up with the inflow of water.....	None. The backup pump was activated as needed	

Potential Cause	ABNORMAL SOUND OR VIBRATION	Solutions
Check valve is broken.....	Make sure check valve is functioning, or replace it	
Discharge pipe is clogged or frozen.....	Clear the discharge pipe	
Defective pump.....	Replace pump	

## Limited Warranty

By opening this package and using this GLETRONICS, INC. product, you are agreeing to be bound by the terms of the GLETRONICS, INC. limited warranty ("warranty") as set out below. Do not use your product until you have read the terms of the warranty. If you do not agree to the terms of the warranty, do not use the product and return it within the return period stated on your purchase receipt from the retail store or authorized distributor where you purchased it for a refund.

To the extent permitted by law, this warranty and the remedies set forth are exclusive and in lieu of all other warranties, remedies and conditions, whether oral, written, statutory, express or implied. GLETRONICS, INC. disclaims all statutory and implied warranties, including without limitation, warranties of merchantability and fitness for a particular purpose and warranties against hidden or latent defects, to the extent permitted by law. GLETRONICS, INC. will not be liable for any incidental, special or consequential damages for breach of any express or implied warranties on this product. In so far as such warranties cannot be disclaimed, GLETRONICS, INC. limits the duration and remedies of such warranties to the duration of this express warranty and, AT GLETRONICS, INC.'s option, the repair or replacement services described below. Some states (countries and provinces) do not allow limitations on how long an implied warranty (or condition) may last, so the limitation described above may not apply to you.

Any and all causes of action arising from, filed as a result of or in reference to, this warranty or the products described under this warranty shall be governed by and construed under the laws of the State of Illinois. Any cause of action arising from, filed as a result of or in reference to, this warranty or the products described under this warranty shall be filed only in the Circuit Court of the 18th Judicial District, Lake County, Waukegan, Illinois, or in the Northern District of Illinois if filed in Federal Court. The maximum liability for any product described in this warranty shall be the cost of product replacement only.

If any term is held to be illegal or unenforceable, the legality or enforceability of the remaining terms shall not be affected or impaired.

### What is Covered by this Warranty?

GLETRONICS, INC. warrants to the end purchaser that its pumps, switch and control unit products, and accessories are free from defective materials and workmanship for the periods indicated below:

All parts and labor (excluding installation) for a period of:

- 2-year standard warranty; 4 yrs when purchased WITH the Basement Watchdog Battery (BW-27AGM) AND registered online

The defective product must be returned directly to the factory, postage prepaid with the original bill of sale or receipt to the address listed below. GLETRONICS, INC., at its option, will either repair or replace the product and return it postage prepaid.

### What is NOT Covered by this Warranty?

This warranty does not cover the cost or value of damaged property, including expressly any property that has been affected by water overflow, seepage or flooding. If GLETRONICS, INC. determines that a product is deemed defective under this warranty agreement, it will repair or replace the PRODUCT ONLY. GLETRONICS, INC. will not cover the cost to reinstall the product, nor will GLETRONICS, INC. pay the cost of having a plumber or contractor repair or replace the product.

GLETRONICS, INC. will not repair or replace a product that was installed incorrectly. A product shall be considered "installed incorrectly" when it deviates in any way from the instructions described in this manual.

This warranty does not cover product problems resulting from handling liquids hotter than 104 degrees Fahrenheit, handling inflammable liquids, solvents, strong chemicals or severe abrasive solutions; user abuse; misuse, neglect, improper maintenance, commercial or industrial use; improper connection or installation, damages caused by lightning strikes; excessive surges in AC line voltage; water damage to the controller; other acts of nature, or failure to operate in accordance with the enclosed written instructions.

### How to Obtain Warranty Service

Within thirty (30) days of the product's defective performance, the unit must be shipped, freight prepaid, or delivered to GLETRONICS, INC. to provide the services described hereunder in either its original carton and inserts, or a similar package affording an equal degree of protection. Products not received by GLETRONICS, INC. at the address indicated below within thirty (30) days of the product's defective performance will not be considered for warranty service. Products received after two (2) years from the date of purchase, fall outside of the timeframe for warranty service and will not be eligible for warranty service. The product must be returned to GLETRONICS, INC. for inspection in order to be considered for warranty service. If the product is not returned to GLETRONICS, INC. or the product is inspected by any person, plumber, contractor or business other than GLETRONICS, INC., this warranty shall no longer be valid. Prior to defective operation, the unit must not have been previously altered, repaired or serviced by anyone other than GLETRONICS, INC., or its agent; the serial number on the unit must not have been altered or removed; the unit must not have been subject to accident, misuse, abuse or operated contrary to the instructions contained in the accompanying manual. The dealer's dated bill of sale, or installer's invoice must be retained as evidence of the date of purchase and to establish warranty eligibility.

### Where are Products Sent for Warranty Service?

Glenetronics, Inc., 645 Heathrow Drive, Lincolnshire, IL 60069

### How Can I Obtain More Information?

By calling 800-991-0466.

# Watching Out for You!

Scan the QR code to tap into a wealth of knowledge and get the most out of your CITE-33 combination sump pump system. Or visit our vast collection of online resources by typing in this URL directly into your Web browser:

[www.basementwatchdog.com/support/cite-33-combination-sump-pump-resources/](http://www.basementwatchdog.com/support/cite-33-combination-sump-pump-resources/)



## Installation

- Manuals
- Videos



## User Resources

- Guides
- Parts



## Maintenance

- Checklists
- FAQs



## General Info

- Warranty
- Brochure

---

**Ask Our Experts:** Our industry-leading technical support department, located right here in the heartland of the U.S., is staffed by a team of experts. We offer free lifetime support, and our top priority is providing you with the finest customer experience anywhere.



Email [service@basementwatchdog.com](mailto:service@basementwatchdog.com)



Follow us on Facebook: [www.facebook.com/BWDPumps](http://www.facebook.com/BWDPumps)



Call (800) 991-0466



Check out our YouTube channel: [www.youtube.com/c/BasementWatchdog](http://www.youtube.com/c/BasementWatchdog)

---

**We're Here Every Step of the Way:**

- Installation Guidance
- Maintenance Recommendations
- Assistance Throughout the Life of Your Product

# Additional Products to Help Protect Your Basement

## Basement Wash-Dog SUMP SYSTEM CLEANER WDT20



### FEATURES AND BENEFITS:

- Removes iron ochre—the red slime buildup—and other contaminants from your sump system and pit
- Keeps your sump pump and pit healthy
- Great solution for required periodic sump system maintenance and cleaning
- Easy to use
- Safe for the environment
- Made from a naturally occurring compound and 100% biodegradable

## Maintenance Free Battery BW-27AGM



### FEATURES AND BENEFITS:

- No need to add battery fluid or distilled water
- Runs our backup sump pump systems intermittently for days
- Lasts longer in standby operation
- Lasts longer and performs better than automotive or deep cycle batteries
- Designed to be discharged and recharged for use with battery backup sump pump systems

## Water Alarms BW-WA360



### FEATURES AND BENEFITS:

- Patented design allows it to detect water on any side
- Senses as little as 1/32" of water
- Compact size (2 3/8" x 1" x 3 1/4") fits almost anywhere
- Piercing 110 dB alarm can be heard throughout the house
- Solid-state circuitry is extremely sensitive and reliable

## BW-HWA



### FEATURES AND BENEFITS:

- Detects leaks before costly water damage is caused
- Save money by detecting leaks early
- Can be placed directly on floors or mounted for installation in a variety of locations

## Sewage Pump SW-50T 1/2 HP



### FEATURES AND BENEFITS:

- Cast-iron/stainless-steel construction for durability
- Noncorroding, stainless-steel hardware
- Adjustable tether switch
- 4,400 GPH @ 10 ft. lift
- 6,000 GPH @ 0 ft. lift
- 3-year limited warranty
- Permanent split capacitor motor increases energy efficiency
- Upper & lower ball bearings for quiet operation and extend the life of the motor
- 2" inlet and discharge



